

Trademark

Shenzhen OBDSTAR Technology Co., Ltd. (hereinafter referred to as "OBDSTAR") has registered trademarks in China and several overseas countries. OBDSTAR® is a registered trademark of the Company. In addition, OBDSTAR insists on independent research and development and innovation, has obtained FCC ID, UKCA and CE certifications, and is a national high-tech enterprise with independent intellectual property rights. Other product and company names mentioned in this product are trademarks owned by other companies.

Copyright Information

Without the written consent of the Company, no company or individual shall copy or back up this manual in any form (electronic, mechanical, photocopying, recording or other forms).

Disclaimer

All information, specifications and illustrations in this manual are current as of publication date. OBDSTAR reserves the right to change it without prior notice. The contents of the manual have been carefully reviewed, but it is still difficult to guarantee the completeness and accuracy of the contents (including but not limited to product specifications, functions and illustrations).

The Company shall not be liable for any direct, indirect, special, incidental damages or any indirect economic damages (including but not limited to loss of profits).

NOTE: Before operating and maintaining the equipment, please read this manual carefully, especially the safety precautions.

Support

Website: <http://www.obdstar.com>

Service Hotline: +86-755-86707161

E-mail: service@obdstar.com

For users in other countries and regions other than China, please contact the local distributor for technical support.

Safety Information

For the safety of yourself and other people, and to avoid damage to the equipment and the vehicle, all personnel operating the equipment must read and follow the safety precautions mentioned in this manual.

Due to the variety of procedures, tools, components and techniques used in vehicle maintenance, the different ways of operation by staff, and the wide variety of diagnostic applications and products tested by the device, this manual cannot predict every situation and give safety advice. It is the automotive service technician's responsibility to fully understand the system being tested and to use appropriate repair methods and testing procedures. When testing, you must use appropriate operating methods, so as not to place yourself and others in the work area at risk, or damage the equipment being used or the vehicle being tested.

Before using the equipment, please refer to and follow the safety information and applicable test procedures provided by the vehicle or equipment manufacturer. Please use the device according to the instructions in this manual, read, understand and obey all safety information and tips in this manual. Please read, understand and obey all the safety information and tips in the manual and use the equipment according to the instructions in this manual.

Safety Instructions

The safety information stated here covers all situations that the Company is aware of. The Company cannot know, anticipate, or advise on all possible hazards. The operator must ensure that the maintenance operations performed under any circumstances will not cause harm to personal safety.

⚠DANGER: While the engine is running, keep the service area well ventilated, or properly connect the engine to the building's exhaust system. Carbon monoxide produced by the engine can cause slow reaction and even serious personal injury or death.

Safety Warnings

- Always perform vehicle diagnostics in a safe environment.
- Keep the diagnostic tool dry and clean, and keep away from gasoline, water and oily items. If necessary, clean the surface of the device with a clean cloth dampened with mild detergent.
- Do not place diagnostic equipment on the vehicle power distribution box, strong electromagnetic interference may cause damage to the equipment.
- Please keep this product away from magnetic devices, as radiation from magnetic devices will erase the information stored in this product.
- Do not use this product in places with high temperature and flammable gas (such as at a gas station).
- Do not use the device during a thunderstorm to avoid lightning strikes or other injuries.
- Never operate the diagnostic scanner while driving, as distraction may cause an accident.
- Wear ANSI-compliant safety goggles.
- Keep clothing, hair, hands, tools, testers, etc. away from running or hot engine parts.
- As vehicle emissions are bodily harmful, diagnosis must be performed in a well-ventilated place.
- Before starting the engine, make sure to apply the parking brake, use a barrier to block the front wheels, and put the shift lever in neutral (manual transmission) or park (automatic transmission), so as not to suddenly move forward and injure people when the engine is started.
- Exercise extreme care when working around ignition coils, distributor covers, ignition lines and ignition plugs. These components generate high voltages when the engine is running.
- Equip special fire extinguishers for gasoline, chemicals and electrical fires in the work area.

- Do not connect or disconnect diagnostic equipment when the ignition switch is on or the engine is running.
- When disassembling and installing the programmable read-only memory (PROM), the operator should wear a grounding metal strap, wrap one end of it around the wrist, and clamp the other end on the vehicle body to avoid ECU circuit failure caused by static electricity.
- When servicing the vehicle, please refer to the instructions in the maintenance manual, and operate in strict accordance with the diagnostic procedures and precautions. Failure to do so may result in personal injury or damage to the diagnostic equipment.
- To avoid damage to the scan tool or the generation of erroneous data, please ensure that the vehicle's battery is sufficiently charged and that the connection to the vehicle's diagnostic seat is clean and secure.
- Radio waves generated by this device may affect the normal operation of implantable medical devices or personal medical devices such as pacemakers, cochlear implant, hearing aids. If you are using these medical devices, consult your manufacturer for restrictions on the use of this device.
- In medical and healthcare settings where the use of wireless devices is expressly prohibited, please follow the regulations of the location to turn off the device.
- The wireless device may interfere with the aircraft's flight system, please comply with the relevant provisions of the airline. When the use of wireless devices is prohibited, please turn off this device.
- This device and its accessories may contain small parts, please keep them out of the reach of children. Prevent children from unintentionally damaging this device and its accessories, or swallowing small parts that may cause suffocation or other hazards.

Table of Contents

1 Manual Overview	1
1.1 Conventions	1
1.1.1 Bold and Square Brackets	1
1.1.2 Terminology	1
1.1.3 Tips and Notes	1
2 Product Profile	1
2.1 Intelligent Diagnostic Scanner	2
2.1.1 Interfaces and Functions	2
2.1.2 Power Supply	3
2.1.3 Test Main Cable	4
2.1.4 Accessories	4
2.1.5 Specifications	4
3 How to Use This Device	5
3.1 Powering On	5
3.2 DP Menu	6
3.3 Screen Locator and Buttons	9
3.4 Powering Off	10
3.5 Reboot	10
4 Diagnostic Operation	10
4.1 Establishing Vehicle Communications	10
4.1.1 Connecting to the Vehicle	10
4.1.2 Communication Failure Prompt	11
4.2 Diagnostic Procedure	12
5 Personal Center	12
5.1 User Registration	12
5.2 User Login	14
5.3 My Info	15
5.4 Recharge CREDIT	17
5.5 Authorization Center	17
5.6 Order History	18
6 Upgrade	19
7 Data Management	21
7.1 My Data	22
7.2 Data Playback	22
7.3 Uninstall Model	23
7.4 Diagnose Report	24
7.5 Picture Viewer	25
7.6 File Management	26
8 Support	26
8.1 Video	27
8.2 Manual	27
8.3 FAQ	28

8.4 Log Upload	28
8.5 Team Viewer	29
8.6 Feeding Exceptions Back	30
8.7 APP Download	31
9 Settings	32
9.1 VCI Info	32
9.2 Language	32
9.3 Unit	33
9.4 Workshop	34
9.5 Network Test	34
9.6 Clear Cache	35
9.7 System Settings	36
9.8 About	36
10 Other Apps	37
10.1 Wi-Fi	37
10.1.1 Setting Wi-Fi	37
10.1.2 Connecting to WLAN	37
10.2 Browser	37
10.2.1 Opening the Browser	37
10.2.2 Browsing Webpages	37
10.2.3 Zooming In/Out Pages	38
10.2.4 Creating New Pages	38
10.2.5 Customizing Browser Settings	38
10.3 Calculator	38
10.4 Camera	38
10.5 Gallery	39
10.6 Clock	39
10.6.1 Alarm	39
10.6.2 Timer	40
10.6.3 Stopwatch	40
10.6.4 Custom Settings	41
10.7 ES File Explorer	41
10.7.1 How to Transfer Files Using USB Flash Drive	41
10.8 OTA (Over-the-Air Technology)	43
10.9 Screen Recording	44
10.10 Screen Projection	45
10.11 Display	47
10.11.1 Brightness	47
10.11.2 Auto Orientation	47
10.12 Setting Screen Lock	47
10.13 Application Management	47
10.14 Languages & Input Methods	48
10.14.1 Setting Languages	48
10.14.2 Setting Keyboards	48

10.15 Setting Date & Time	48
10.16 Restoring Factory Settings	48
10.17 Storage	49
11 Scanner Care	49
12 Usage of the Battery and the Charger	49
13 Order Notification	50
14 Customer Service Center	50
15 Warranty	50

1 Manual Overview

This manual contains instructions for using the device.

Some of the diagrams shown in the manual may include all the modules and optional devices in the system you use. You can contact local sales or dealers for the information and the purchasing of other optional modules and accessories.

1.1 Conventions

The content of the manual has the following conventions.

1.1.1 Bold and Square Brackets

In the body of the manual, bold and square brackets emphasis is used to highlight optional items, such as buttons and menu options.

For example:

Tap **[OK]**.

1.1.2 Terminology

The term "select" means to highlight a button or menu item and tap it to confirm the selection.

1.1.3 Tips and Notes

This manual uses the following messages.

Tips:

Tips provide helpful information such as additional usage instructions, tips, and advice.

Notes:

Notes remind you to avoid (avert) situations to prevent damage to the diagnostic tool or the vehicle.

2 Product Profile

This product is a new Android-based vehicle trouble diagnostic device developed for Internet applications. With OBDSTAR's advanced diagnosis technology in its blood, it has the advantage of wide vehicle coverage, diverse functions and accurate test data. Communicating through the OBD connector, the smart mobile terminal realized fault

diagnosis for all vehicle models and systems.

In addition, taking advantage of mobile Internet applications, this device shares the resources, support, etc. of all our products.

2.1 Intelligent Diagnostic Scanner

2.1.1 Interfaces and Functions

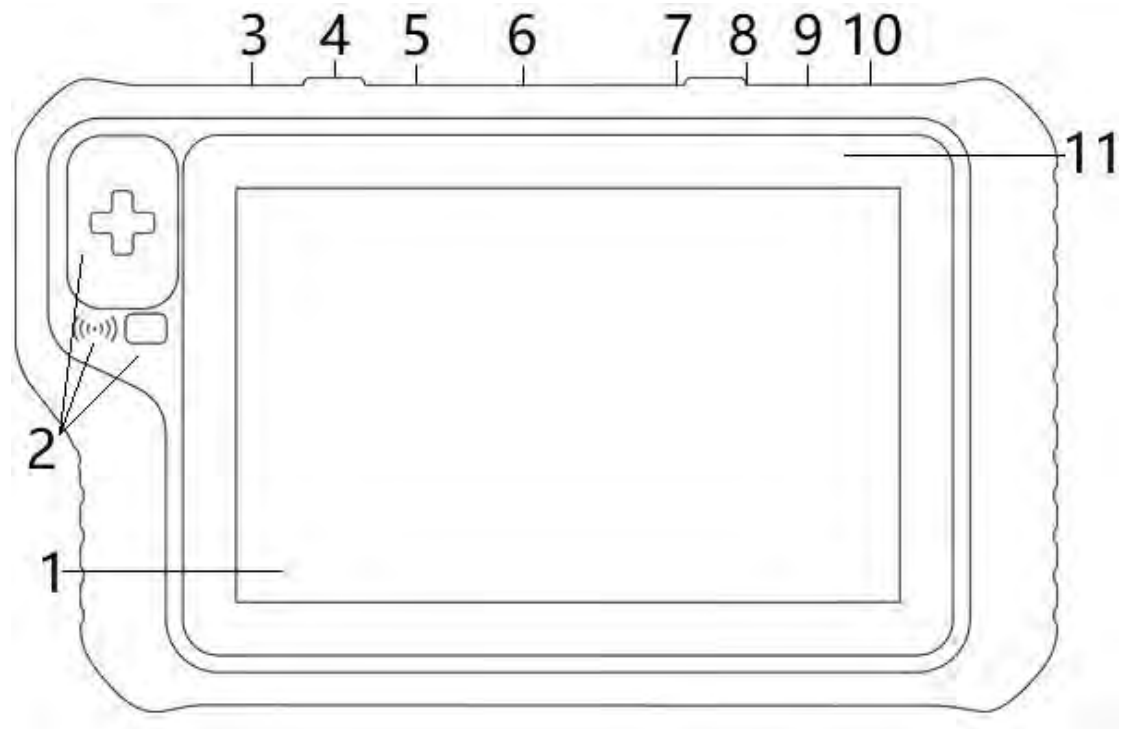

Fig. 2.1.1-1 Front View of the Device

- 1 - 8" LED Capacitive Touch Screen
- 2 - Key/Chip/ Remote Sensing Area
- 3 - RJ45 Interface
- 4 - HDMI Interface
- 5 - USB Interface
- 6 - Connector Interface for Main Diagnostic Cable
- 7 - TF Card Slot
- 8 - Type-C Interface
- 9 - DC Charging Interface
- 10 - ON/OFF Button - Long press to turn on/off the tablet; briefly press to lock/unlock the screen.
- 11 - Power Indicator Light

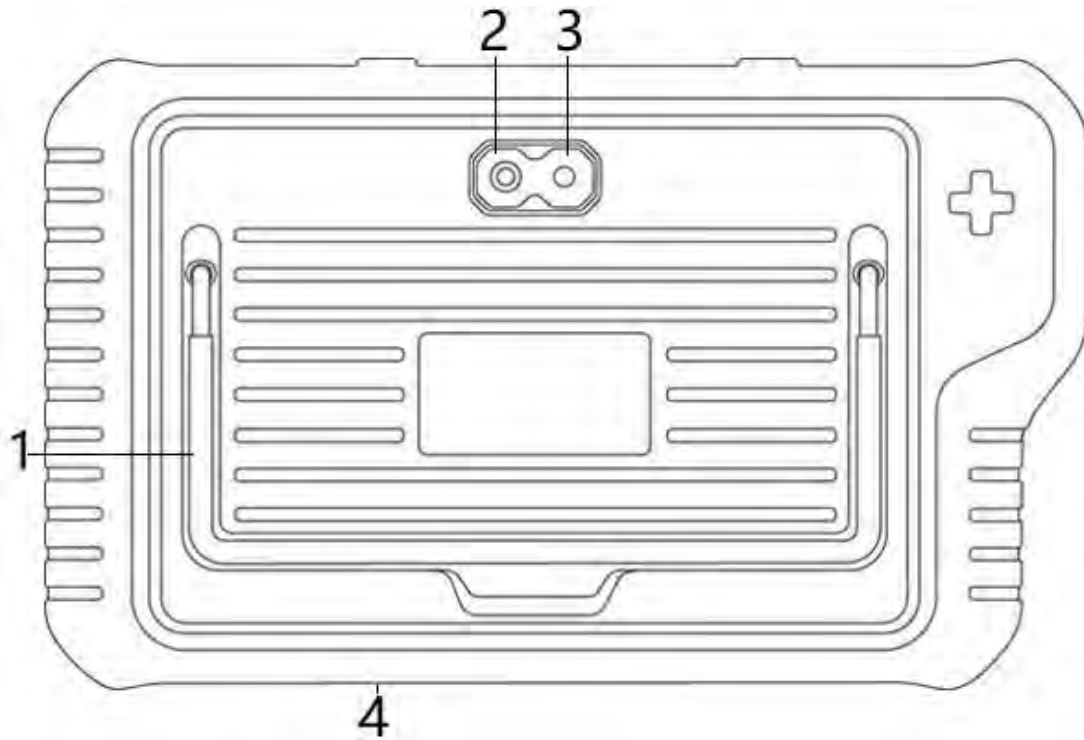

Fig. 2.1.1-2 Rear View of the Device

- 1 - Foldable Stand - Deploy it from the back of the tablet for stable placement and hands-free browsing.
- 2 - Camera Lens
- 3 - Camera Flash
- 4 - Speaker

2.1.2 Power Supply

The smart diagnostic scanner can be powered by:

- 1) internal rechargeable battery
- 2) AC/DC power supply
- 3) vehicle power

The intelligent diagnostic scan tool can be powered by the internal rechargeable battery. When the battery is fully charged, it can support 4.5-hour-long on-screen data viewing. The device can be powered from a wall outlet using the AC/DC power connector. The AC/DC power connector supplies the internal battery pack. And the tablet can be powered by a direct connection to the cigarette lighter or other available power port on the vehicle.

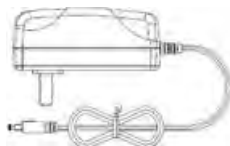
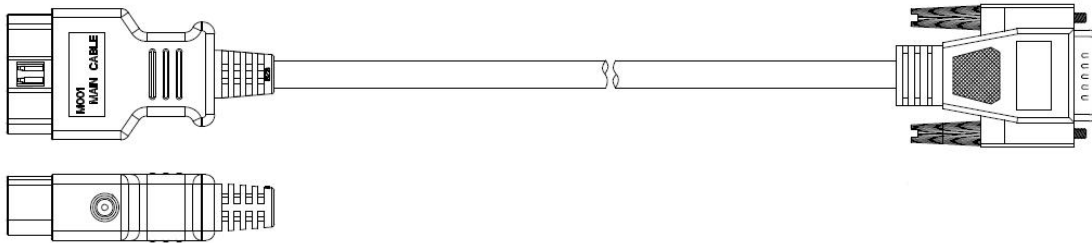

Fig.2.1.2 AC/DC Power Connector

2.1.3 Test Main Cable

It is used to build the connection between the diagnostic scanner and the vehicle to be tested.



2.1.4 Accessories

Accessories vary with product configuration. Some features require specific accessories. Please contact our customer service department or an authorized dealer for details or to place an order.

2.1.5 Specifications

Operating System	Android 11
CPU	Quad-Core Cortex-A53, 2.0GHz
Battery	9000 mA, polymer lithium-ion battery
Expansion Memory Card	32G Micro SD (TF) card supported
Storage	64GB
LCD	8.0-inch integrated screen
LCD Resolution	1280*800
Touch Screen	Capacitive
Camera	Rear camera, 8 million pixels
Wi-Fi	Wi-Fi supported
Working Temperature	-10°C ~ 55°C (14°F ~ 131°F)

Storage Temperature	-20°C ~ 70°C (-4°F ~ 158°F)
Weight	About 1.5kg
Dimension	270.5mm*165mm*35mm

3 How to Use This Device

Before using this device, please ensure that the built-in battery is fully charged or connected to a DC power supply (see the power supply paragraphs for details).

3.1 Powering On

Press the Lock/Power button on the top right of the device for three seconds to power it on, the system will start up and show the lock screen. Swipe up on the screen to unlock it, and then the Disclaimer window will pop up before navigating to the DP main menu. Scroll down to the end of the pop-up dialog box and read the Disclaimer thoroughly. After that, **[Agree]** with this Disclaimer and the system will show DP menu; otherwise, **[Reject]** to Android system homepage.

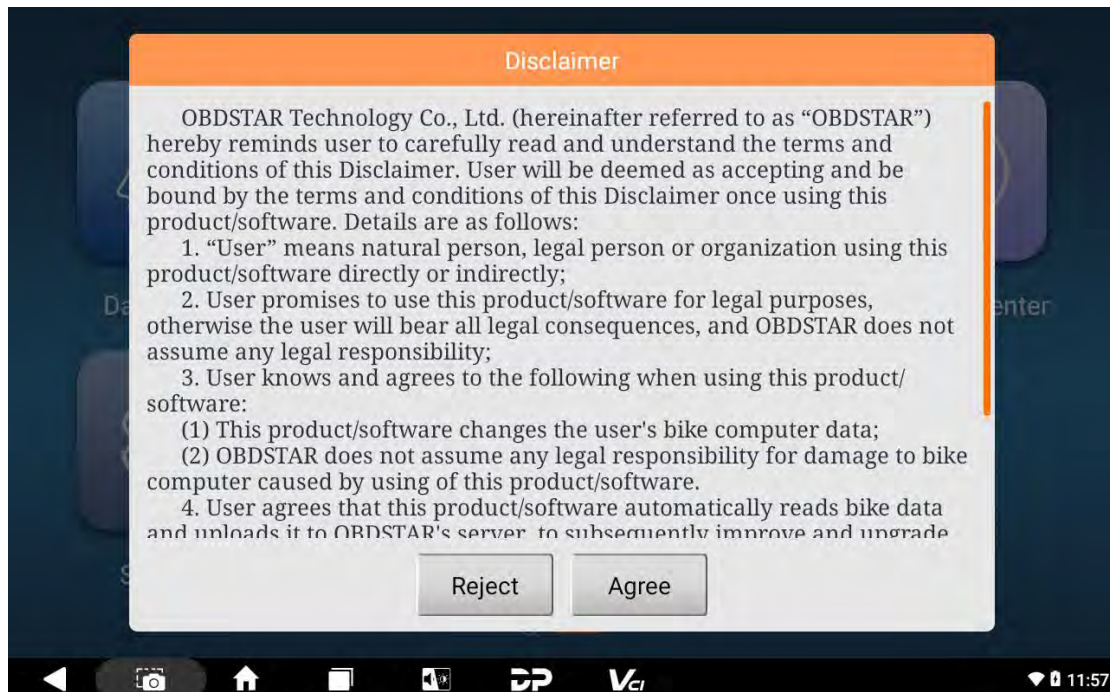

Fig. 3.1-1 DP Apps Disclaimer

3.2 DP Menu

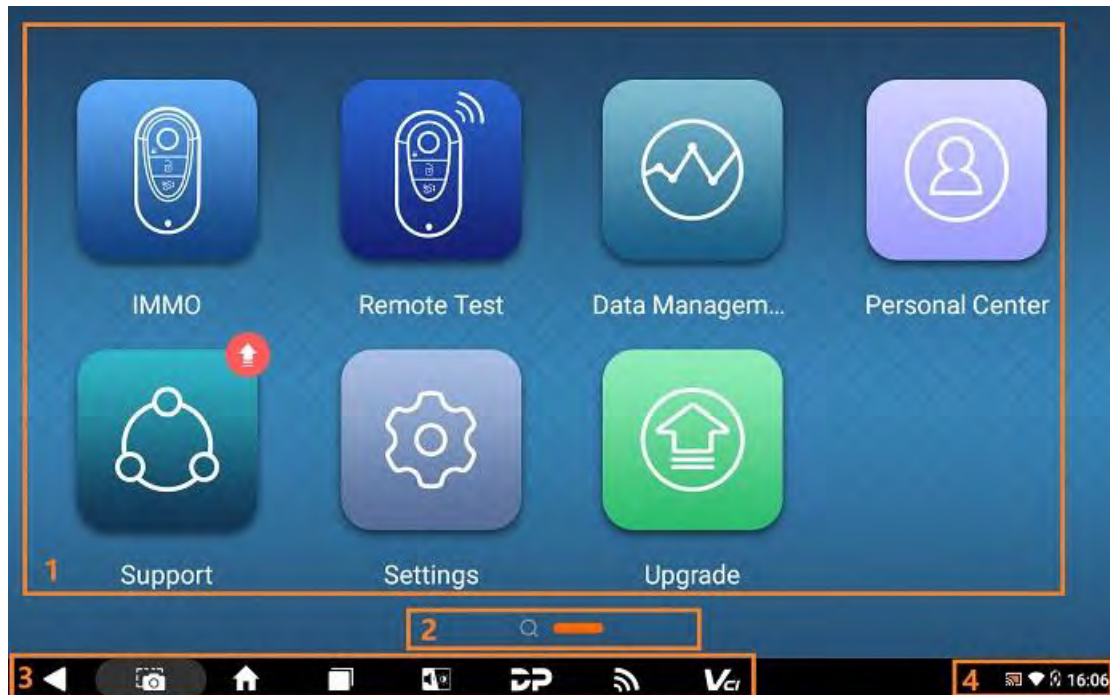

Fig. 3.1-2 DP Apps Menu

- 1) Application menu
- 2) Screen locator
- 3) Navigation buttons
- 4) Bluetooth, WLAN, Battery and System Time

Tip: In order to protect system information security and reduce power consumption, the screen will be locked and the system enters hibernation when the device is not used for a long time. You can modify this setting in the Display option of the system settings menu.







All operations of the intelligent diagnostic device are performed via the touch screen. Diagnostics are primarily guided by menu selection, so the user proceeds through a series of question/option selections to perform diagnostic actions or data searches. The following chapters will describe operations on specific applications.

Users can choose to run different apps through the DP menu. The table below provides a brief description of the DP apps. Please use a stylus or your fingertip to select and tap for application running.



Note: Below is a **non**-exhaustive list of our software. Subject to the actual downloaded software.

Table 3.2 DP Apps

App Name	Icon	Description
----------	------	-------------

IMMO		It operates anti-theft system diagnosis on motorcycle and marine applications.
Remote Test		It can test the frequency of remote control.
RFID		It is used to refresh key chip.
Personal Center		It is used for checking personal account information, token information, etc.
ODO METER		It is used for recalibrating odometer.
Airbag Reset		It operates airbag reset.
ECU Flasher		This function is to read ECU data from the original car, and to write the read data into the new ECU.





Upgrade		It is used for diagnostic software update.
Test Platform		It integrates new energy compressor drive, new energy DCDC drive, and new energy 48V start/stop drive. In addition, instrument drive, audio drive, ABS drive, gear lever drive, A/C panel drive and other functions are optional.
Programmer		It is used for key refresh.
Service		It is used to operate service diagnostic program.
OBDII		It is used for passenger vehicle diagnosis.
Data Management		It is used to check recorded data, to diagnose report and other data, and to uninstall models.
Support		It is used to check product manual and FAQs, as well as to upload logs, to give feedbacks on exceptions and to perform remote assist.

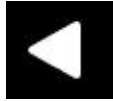

Settings		It operates language switching, unit system switching, workshop information editing, cache clearing, etc.
Data Query		It is used to search data.

3.3 Screen Locator and Buttons

The following table describes the operating functions of the navigation buttons located at the bottom of the screen:

Table 3.3 Screen Locator and Buttons

Name	Icon	Description
Screen Locator		It indicates the location of the screen you are viewing (in orange). Swipe left and right on the screen to flip through the front and rear pages, and the leftmost page can quickly search for diagnostic software.
Back		It is used to return to the previous interface or exit the application.
Camera		By tapping and holding on it, you can shot the screen and save the image. The saved files will be automatically stored in the data management for later use. Tap it briefly and you will go to the photo/recording interface.
Home		Tap it to go back to the main interface of Android System.
Recently Used Apps		Tap it to check cascaded thumbnails of the operating apps. Select the thumbnail of the desired app to open the app, and drag out a thumbnail can close the according app.
Volume & Brightness		The brightness & volume adjusting window will pop up upon tapping on it.

Remote Frequency Test		Tap it to open the interface of remote frequency test.
DP		Tap it to return to the menu page of DP apps.
VCI		It is used to open the setting management interface and check VCI information.

3.4 Powering Off

All vehicle communications must be terminated before switching off the smart diagnostic device. Forced shutdown while communicating may cause problems with some vehicles' ECM, so please exit the diagnostic application before shutting down.

Powering off procedure:

- 1) Press and hold the **[Lock/Power]** button for 2-3 seconds.
- 2) After selecting **[Power off]**, the system will shut down in a few seconds.

3.5 Reboot

- a) Press and hold the **[Lock/Power]** button for 2-3 seconds.
- b) After selecting **[Reboot]**, the system will reboot in a few seconds.

4 Diagnostic Operation

The diagnostic program establishes a data connection with the vehicle ECU through the diagnostic main line, and can read ECU information, view fault codes, check data flow parameters, and perform actuation tests. Diagnostic applications access multiple ECUs (Electronic Control Units) for vehicle control systems such as engine, transmission, anti-lock braking system (ABS), etc..

4.1 Establishing Vehicle Communications

- 1) Attach the diagnostic main cable (Some functions require appropriate adapter or other accessories. Please refer to software operating instructions for detailed operations) to the vehicle's diagnostic socket for power supply and communication.
- 2) Ready to diagnose and service the vehicle.

4.1.1 Connecting to the Vehicle

Based on the different configurations of the vehicle, the methods for connecting the

intelligent diagnostic equipment and the vehicle diagnostic socket are divided into the following two types:

- 1) Vehicles compatible with OBD II management system communicate and are powered with 12V through a standard SAE J1962 diagnostic socket.
- 2) Vehicles that are not compatible with OBD II management system communicate through a non-standard diagnostic socket and, in some cases, are powered with 12V from a power adapter of smart scanner or the vehicle battery.

◆Connecting to OBD II Vehicle

Connecting to an OBD II vehicle only requires the use of the test main cable, no other connectors are required.

Connection method:

- 1) Connect the male connector of the main diagnostic cable to the smart scanner and tighten the captive screw.
- 2) Attach the 16-pin connector of the main test cable to the vehicle diagnostic socket. and for the location of the socket, you can refer to the help data in the diagnostic software.

◆Connecting to Non-OBD II Vehicle

Connecting to a non-OBD II vehicle requires a combination of the test main line and the test vehicle-specific adapter.

Non-OBD II vehicle connections can have the following two connection scenarios:

- 1) The diagnostic interface connection provides communication and power.
- 2) The diagnostic interface can only communicate, and needs to be connected to the power adapter of the intelligent diagnostic scanner or the vehicle battery to obtain power (preferred).

Connection method:

- 1) Connect the male connector of the main diagnostic cable to the smart scanner and tighten the captive screw.
- 2) Locate the vehicle-specific diagnostic connector and connect its 16-pin female connector to the male connector of the main test cable.
- 3) Connect the connected dedicated diagnostic connector to the vehicle diagnostic socket.

4.1.2 Communication Failure Prompt

If the intelligent diagnostic tool cannot establish normal communication, the screen will show a communication failure prompt message and provide corresponding inspection instructions. Possible reasons for this issue are as follows:

- 1) The ignition is not turned on.
- 2) The main line is not well connected.
- 3) Faulty vehicle, data cable, or connector wiring.
- 4) The battery is exhausted.
- 5) The vehicle is not equipped with the selected system.

4.2 Diagnostic Procedure

Connect the diagnostic scanner to the vehicle via the test main line -> Register (see Personal Center section for details) -> Log in (see Personal Center section for details) -> Download/Upgrade diagnostic software -> Select functions and models -> Execute the diagnosis -> Complete diagnostics and exit.

NOTE: Before exiting or closing the diagnostic application program, you must first exit the diagnostic operation interface and terminate all communication between the smart device and the vehicle. As communication interruption may cause damage to the vehicle ECU, it is necessary to ensure that the test main cable is well connected with the smart device and the vehicle in the process of diagnostic communication, and ensure that all diagnostic communication has been exited before disconnecting the diagnosis main line or turning off the device.

5 Personal Center

This is used to set up and manage account details and to check dealer's information.

5.1 User Registration

When the user gets a brand new diagnostic scanner, he/she needs to register an account in the Personal Center before logging in the Upgrade app to download the software. Tap the **[Personal Center]** icon in the DP menu, then the login interface will be shown.



If you are a new user, select the **[Register]** button in the lower right corner and proceed to the user registration interface.

The screenshot shows the 'Account information' step of a registration process. At the top, there is a progress bar with three stages: 'Account information' (highlighted in orange), 'Contact information', and 'Register success'. Below the progress bar, there are four input fields: 'Username' (with a person icon), 'Password' (with a lock icon), 'Confirm password' (with a lock icon), and 'Email(password retrieve by Email)' (with an envelope icon). A 'Next' button is positioned below these fields. At the bottom of the screen, there are two links: 'Back to login' on the left and 'Forgot password' on the right. The Android navigation bar at the bottom shows the time as 17:59.

The screenshot shows the 'Contact information' step of a registration process. At the top, there is a progress bar with three stages: 'Account information', 'Contact information' (highlighted in orange), and 'Register success'. Below the progress bar, there is a text prompt: 'For better service, fill in the info carefully!'. This is followed by five input fields: 'Contacts' (with a person icon), 'Cellphone' (with a telephone icon), 'Company name' (with a document icon), 'Address' (with a location pin icon), and 'Post Code' (with a mail icon). A 'Register' button is positioned below these fields. At the bottom left, there is a 'Previous' link. The Android navigation bar at the bottom shows the time as 17:59.

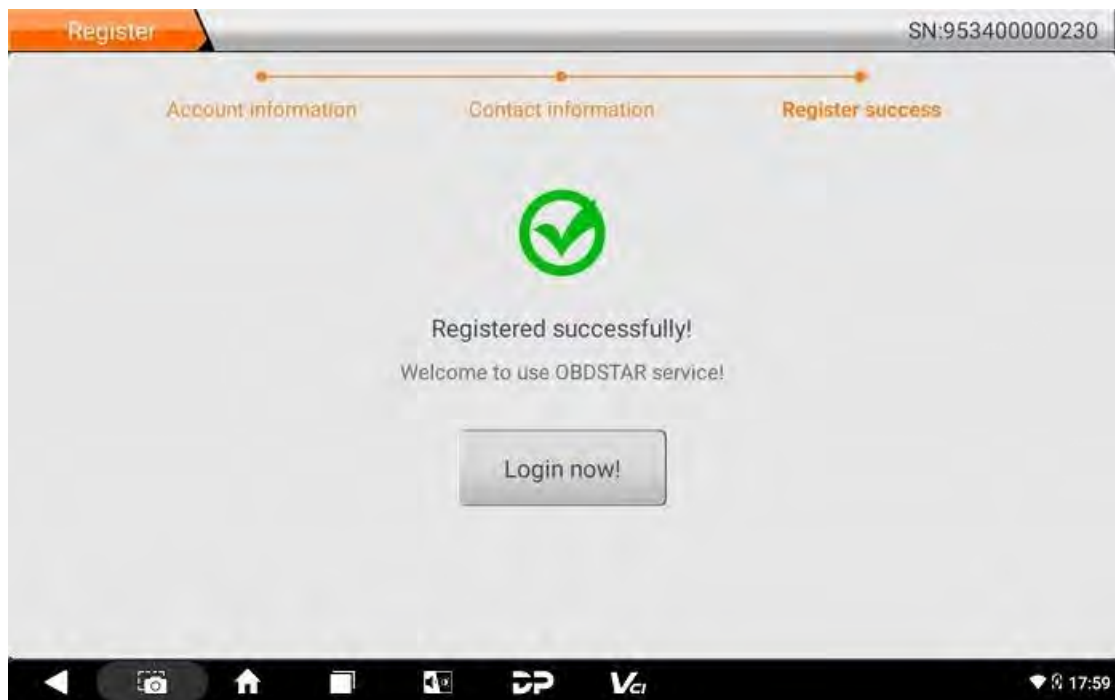

Fill in the information in each field. After that, you will be prompted with “Registered successfully!” Tap **[Login now!]**.

5.2 User Login

If you have already registered as a member, fill in your account number and password, then tap **[Login]**. See the picture below:



If you forget your password, you can select **[Forgot password]**, then fill in the necessary information in the Password Recover popup window, and you will be able to log in with your

new password.

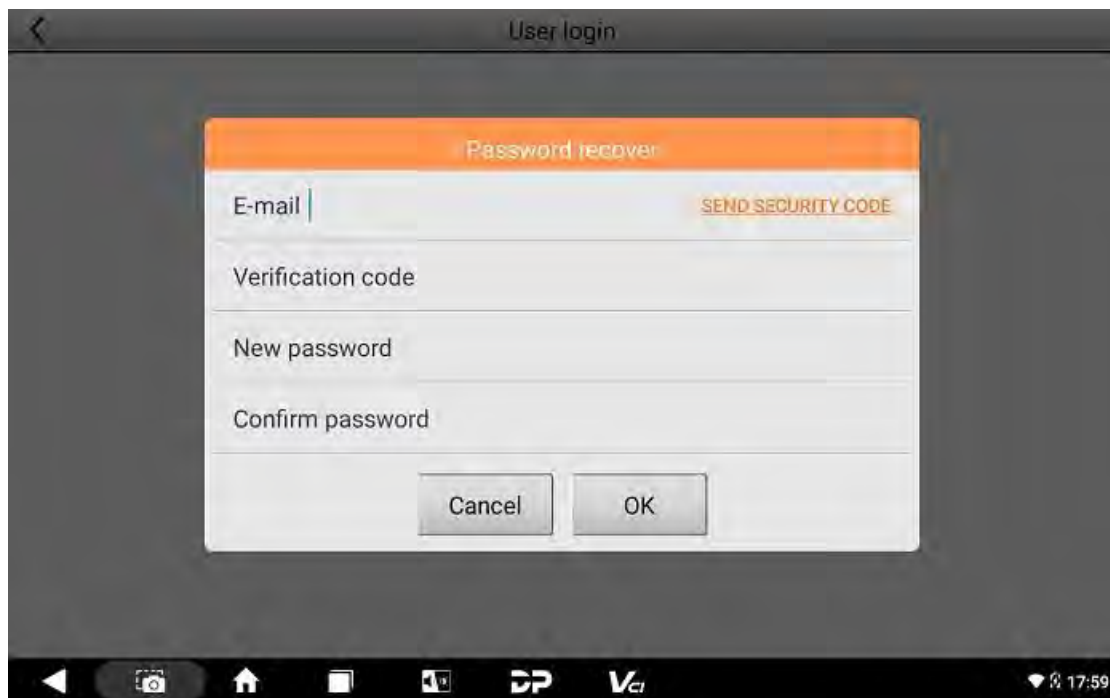

5.3 My Info

If you have already registered, your personal information will be displayed in the My Info interface where you can modify your information and password.



You can check dealer contact info by tapping on the **[Show Info]** in the Dealer Code column

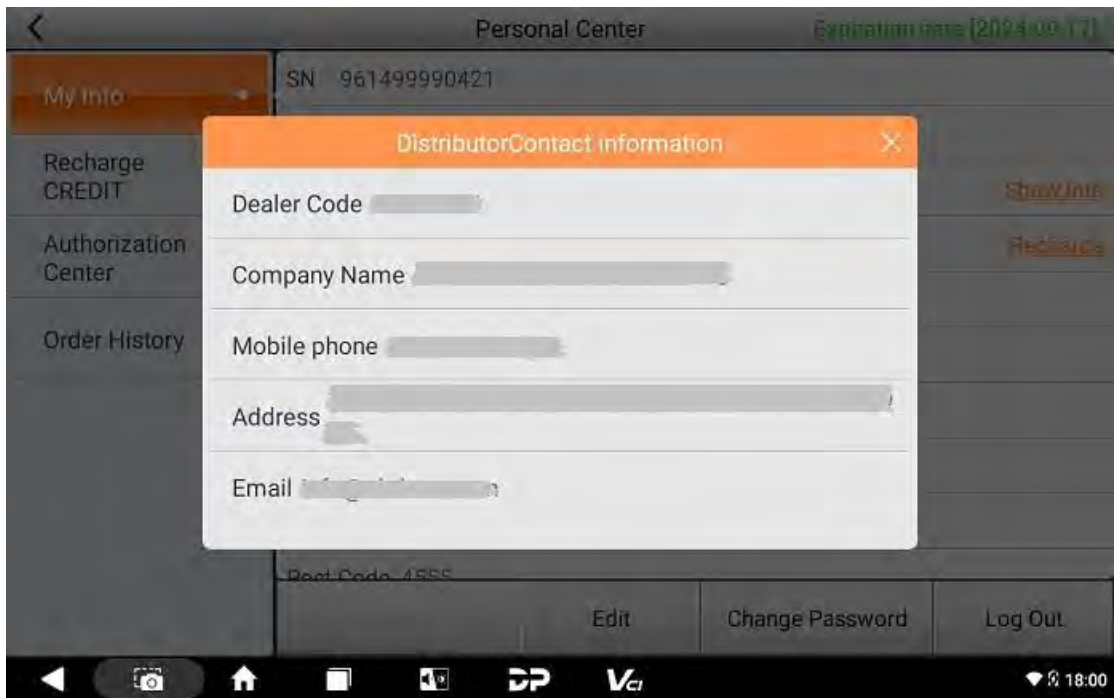

By tapping **[Edit]** in the lower part of the My Info page, you can edit your personal information.



You can tap on **[Change Password]** to change passcode.



5.4 Recharge CREDIT

The Recharge CREDIT tab displays OBDSTAR's contact information through which you can contact the Company for recharge.



5.5 Authorization Center

This access for annual subscription and configuration upgrade has been cancelled. You can

contact the dealer for details.

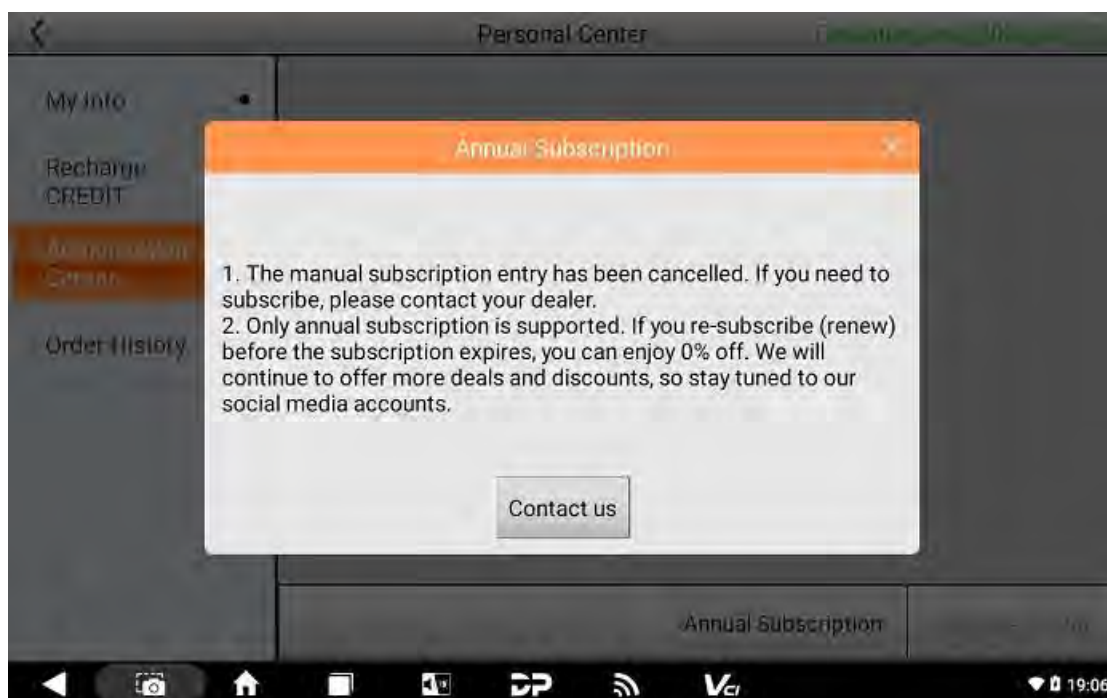
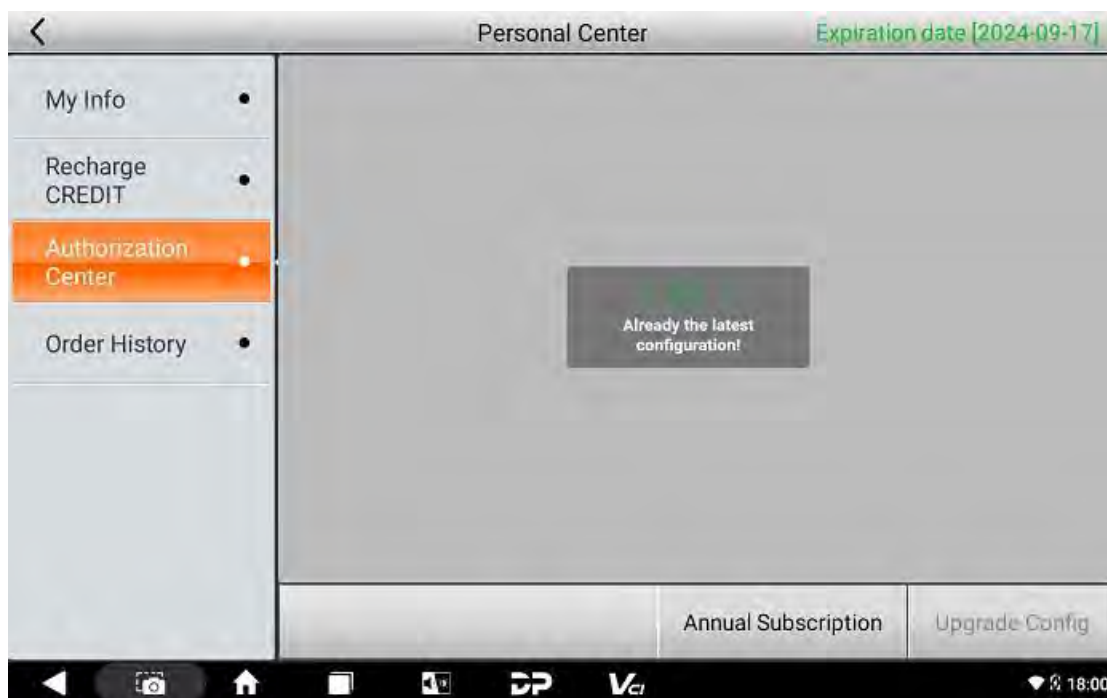

5.6 Order History

Select [Order history] to view your order records.

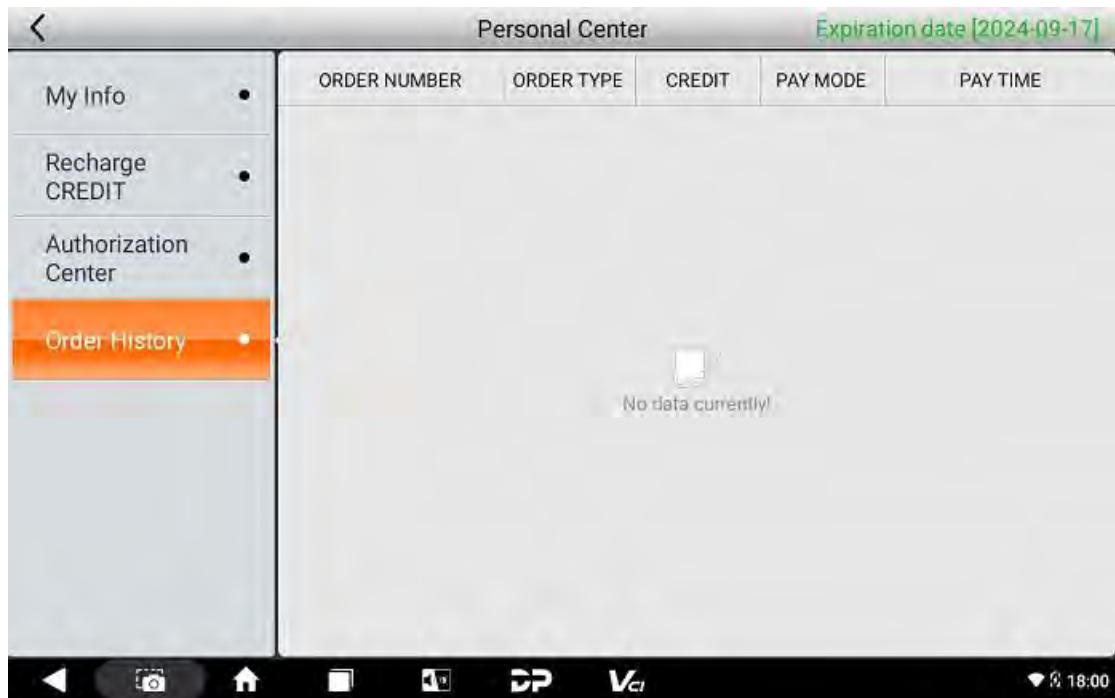

6 Upgrade

Users can download the basic data required for diagnosis, vehicle diagnostic software, data package, etc. in this function module.

Procedure:

- 1) Please log in (please refer to the user registration/login process in the Personal Center section for details) before using Upgrade. After opening the upgrade main page, you can see all upgradable software. All items are checked to upgrade by default. If you want to cancel any software, you can tap the orange check box in front of the corresponding software; and gray check boxes marked with a tick correspond to the software that must be upgraded and cannot be canceled. If you only want to upgrade all or part of the software in the Favorites (a collection of software you frequently use and have added to Favorites), tap the button **[Favorites]** in the lower left corner to select and tick the relevant software. After the selection of the software to be upgraded is done, tap the upgrade button  in the lower right corner to start. In addition, when you want to quickly locate your target software in the long upgrade list, you can use the search box in the upper right corner and just enter key words or letters to search.

Software name	Current version	Downloadable	Upgrade(212/212)	Upgrade Content
BASIC DATA-SOFTWARE	-	-	-	
AIRBAG RESET-CAR-AIRBAG RESET	-	30.49	114.40 MB	
AIRBAG RESET-CAR-BATTERY RESET	-	30.07	3.19 MB	
DIAG-CAR-OBDDII	-	40.27	4.38 MB	
DIAG-E-MOTO-NIU	-	31.00	1.96 MB	
DIAG-MARINE-HONDA	-	31.10	7.77 MB	
DIAG-MARINE-PCM	-	31.00	2.27 MB	
DIAG-MARINE-YAMAHA	-	31.07	3.78 MB	
DIAG-MOTOCYCLE-BMW	-	31.17	13.11 MB	

2) The last column on the main page of the Upgrade is the upgrade content. You can tap the icon button corresponding to the relevant software to view what's new to the current software version (see an example below).

Upgrade

V30.49 2023/10/20

1. Highlights Added 🔥

- Add 105 part numbers for the below models to support airbag reset(92) and Read/Eraser DTC(13):
- Add ACURA SPC56AP54 1 part number;
- Add AUDI 95160,TC27XX-64F 2 part numbers;
- Add BENZ 95640 1 part number;
- Add BMW 95640 1 part number;
- Add BUICK 1 part number;
- Add CHEVROLET R7F7010083 3 part numbers;
- Add CITROEN 95320,95640 13 part numbers;
- Add DODGE 95256 2 part numbers;
- Add FIAT 95640,R7F701018,TC23XX-32F 3 part numbers;
- Add FORD 95320,R7F701064,R7F701A033 4 part numbers;
- Add GEELY XC2361A-72F 1 part number;
- Add GREATWALL R7F701009 1 part number;
- Add HONDA 95640,R7F701686,R7F701A223,SPC560P50,SPC56AP54,TC23XX32F 13 part numbers;
- Add HYUNDAI 95320,SPC560P50,TC23XX-32F 6 part numbers;
- Add INFINITI 95128 1 part number;
- Add JEEP 95512,95640 2 part numbers;

3) If you tap the upgrade button in the lower right corner again during the progress of the upgrade, the lower part of the screen will prompt "Downloading. Please try again after download finished." And the upgraded software will display a green dot indicating completed downloads.

Upgrade					
<input type="checkbox"/>	Software name	Current version	Downloadable	Upgrade(0/27)	Upgrade Content
<input checked="" type="checkbox"/>	BASIC DATA-SOFTWARE	-	-	7.84 MB(0/12) 6.74 KB	
<input checked="" type="checkbox"/>	AIRBAG RESET-CAR-AIRBAG RESET	-	30.49	114.40 MB	
<input type="checkbox"/>	AIRBAG RESET-CAR-BATTERY RESET	-	30.07	3.19 MB	
<input type="checkbox"/>	DIAG-CAR-OBDSII	-	40.27	4.38 MB	
<input type="checkbox"/>	DIAG-E-MOTO-NIU	-	31.00	1.96 MB	
<input type="checkbox"/>	DIAG-MARINE-HONDA	-	31.10	7.77 MB	
<input type="checkbox"/>	DIAG-MARINE-PCM	-	31.00	2.27 MB	
<input type="checkbox"/>	DIAG-MARINE-YAMAHA	-	31.07	3.78 MB	
<input type="checkbox"/>	DIAG-MOTORCYCLE-BMW	-	31.17	13.11 MB	

All Favorites Downloading, please try again after download finished

7 Data Management

The user can select **[Data Management]** in the DP main interface to view its function menu (see the figure below), which includes My Data, DataStream Playback, Uninstall Model, Diagnose Report, Picture Viewer, and File Management.



7.1 My Data

The user can view, copy, paste, delete, and rename data files through this function. For example, backup ECU flash files and U disk files.

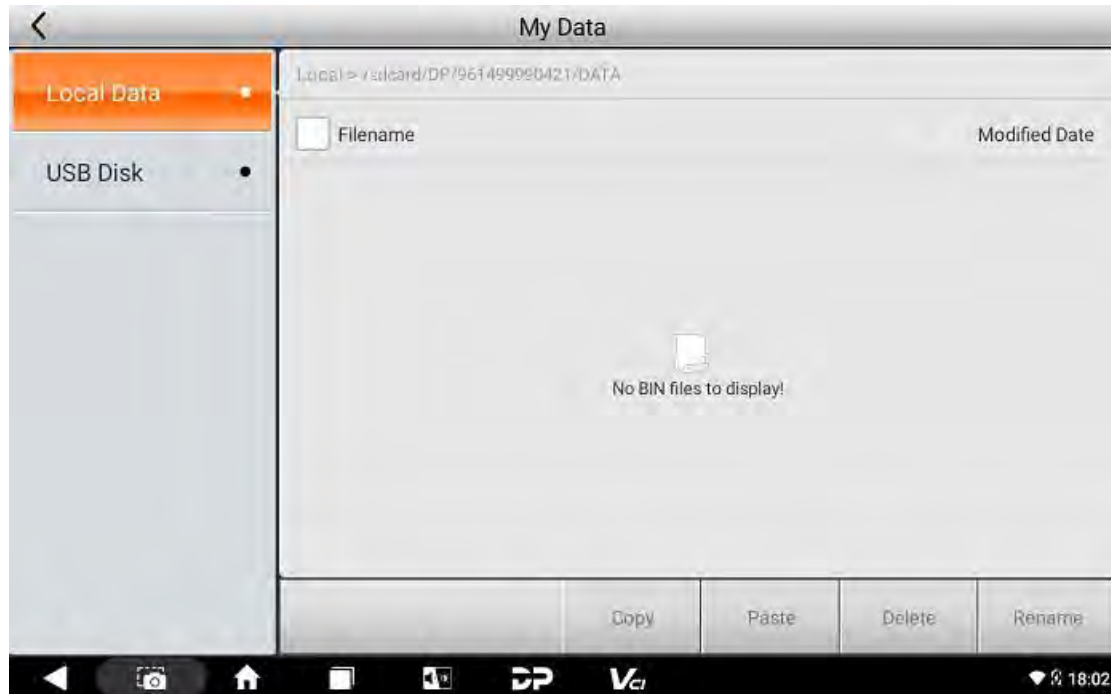

7.2 Data Playback

- The user can check the data stream recorded during diagnosis, including those recorded actively by the user and those triggered by data streams.
- The data videos are sorted by recording date on the left side of the page, and below each date is the number of videos for that day.
- Each video has a time stamp and file path (including the model name), the user can enter the name in the search box in the upper right corner for quick search.
- If you want to delete items, you can firstly tap the delete icon  in the upper right corner, secondly tick the desired item and tick the delete icon again, and finally tap [OK] in the popup box for confirmation.

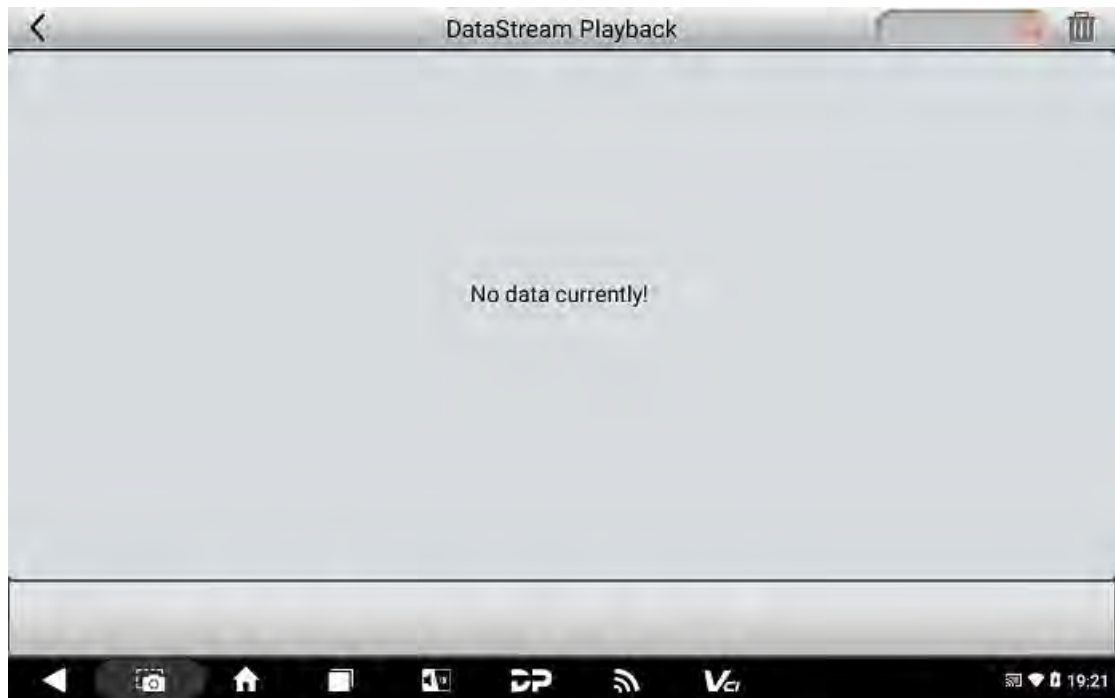

7.3 Uninstall Model

- a) Tap on the **[Uninstall Model]** in the main page of the Data Management to open the page.
- b) The list on the left is classified according to DP function, and different models are equipped with different DP functions.
- c) The user can enter the name in the search box in the upper right corner for quick search.
- d) Tap the model icon or the check box in the lower right corner of the model to select, then tap the delete icon  in the upper right corner of the screen to delete. After the uninstallation is done, tap the upper left button or the lower left one to return to the previous menu.



7.4 Diagnose Report

- a) Tap the icon of Diagnose Report in the main page of the Data Management.
- b) The data is sorted according to the generation time of the diagnostic report by default, and the user can choose to sort by VIN code.
- c) The search box in the upper right corner can help with quick searches by date or time.
- d) Tap **[Enter]** can check the details of the diagnose report, and tap the upper left button or the lower left one to return to the previous menu.
- e) Deleting the report: Firstly, tap the delete button  in the upper right corner; secondly, select the desired report and tap the delete button again, finally tap **[Ok]** in the popup box to confirm your operation and complete the procedure.



7.5 Picture Viewer

- 1) Tap the **[Picture Viewer]** in the main page of the Data Management. (The following picture is an effect image of the main page of the Picture Viewer).
- 2) This page contains the screenshots and pictures took by the user.

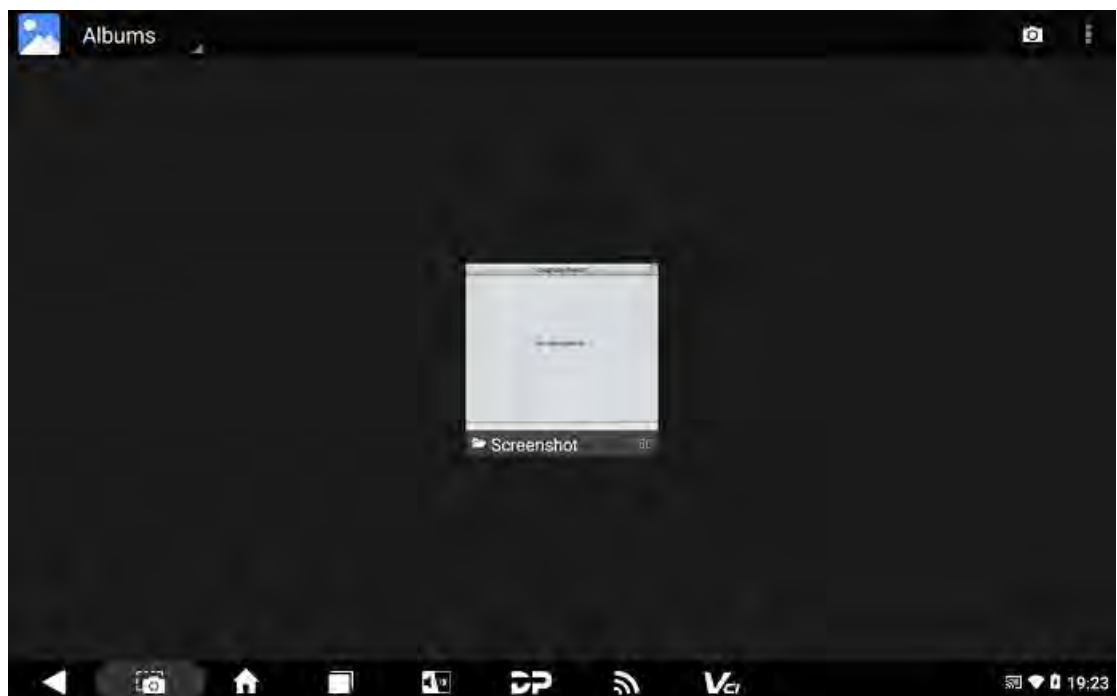

7.6 File Management

Users can manage U disk files, backed-up ECU flash files and other files through this function.

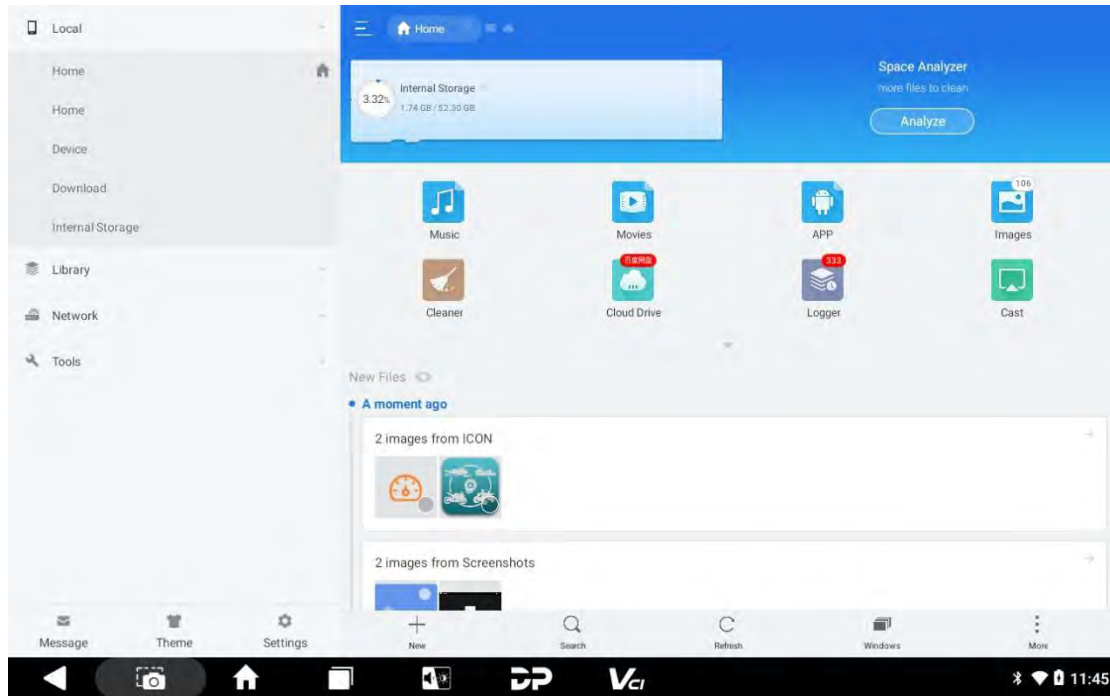

8 Support

The sub-modules of this function module are Video, Manual, FAQ, Log Upload, and Team Viewer.

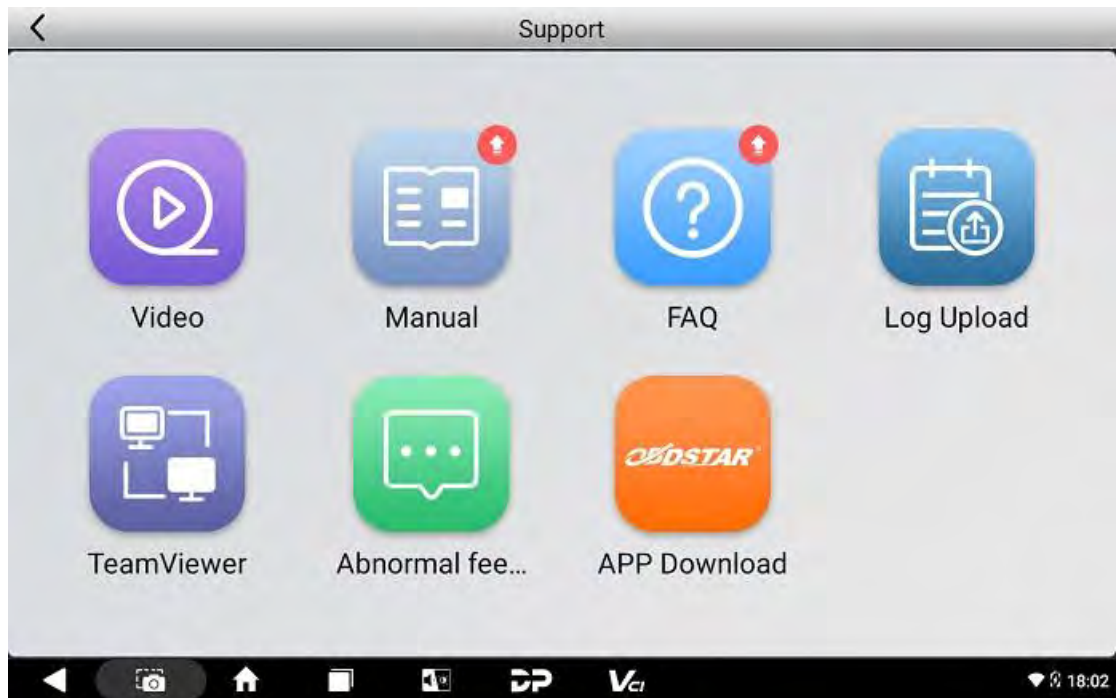

8.1 Video

After tapping on the **[Video]** in the Support main page, you can see a QR code page which can be scanned to watch relevant video on your mobile phone.

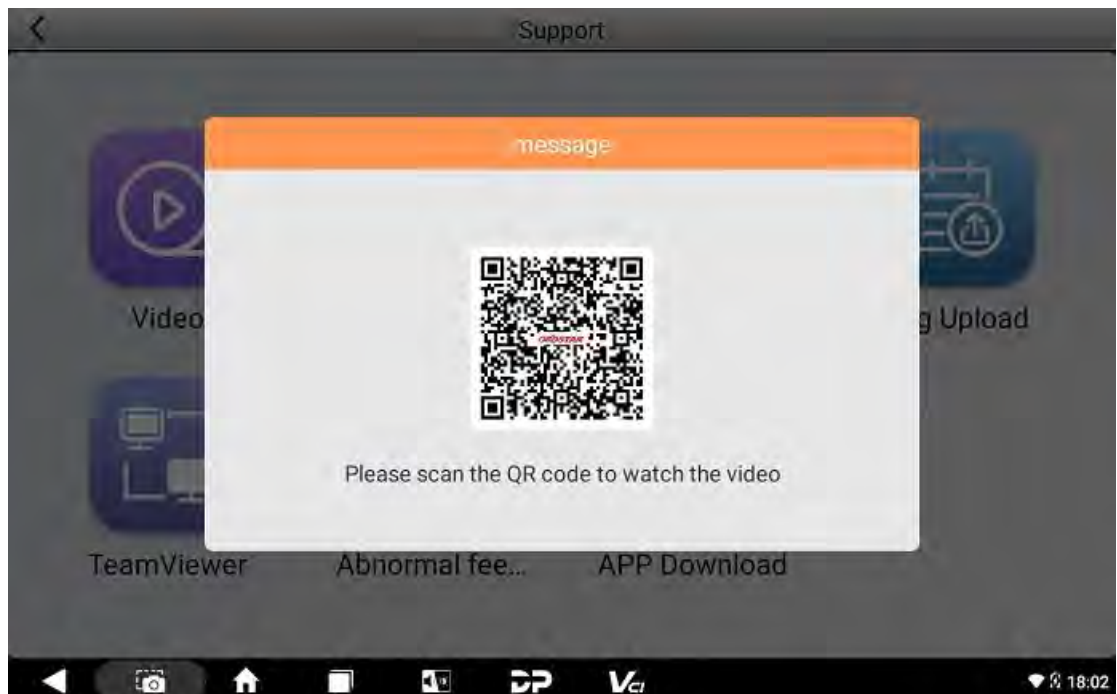

8.2 Manual

For the first time use, the user can see the download prompt after tapping **[Manual]** on the

Support main page. Download to view the content.

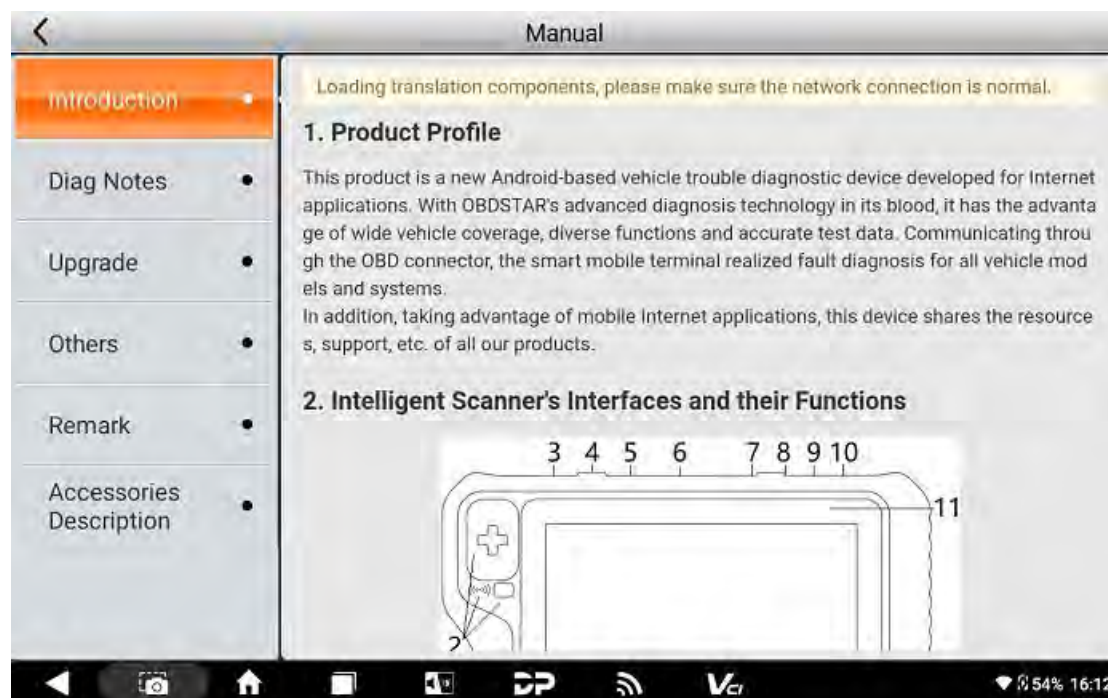

8.3 FAQ

After selecting [FAQ] on the Support main page, you can see the content of FAQ.

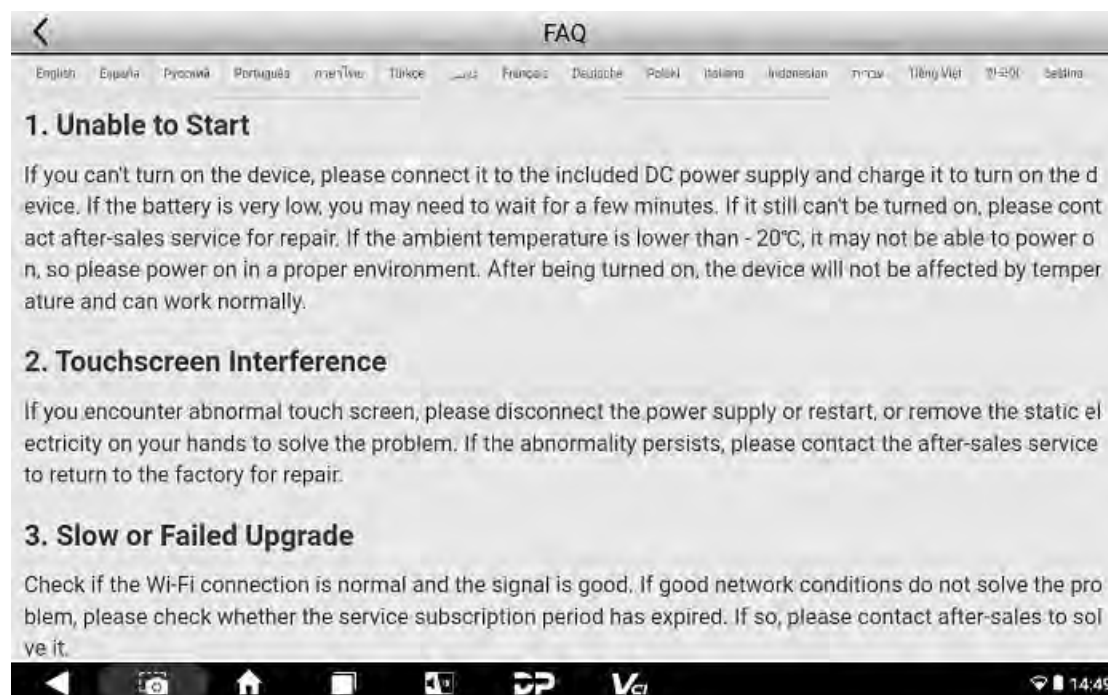

8.4 Log Upload

After selecting the [Log Upload] on the Support main page, the user can see the screen

shown in the figure below. Tap **[Upload]** to upload your log.

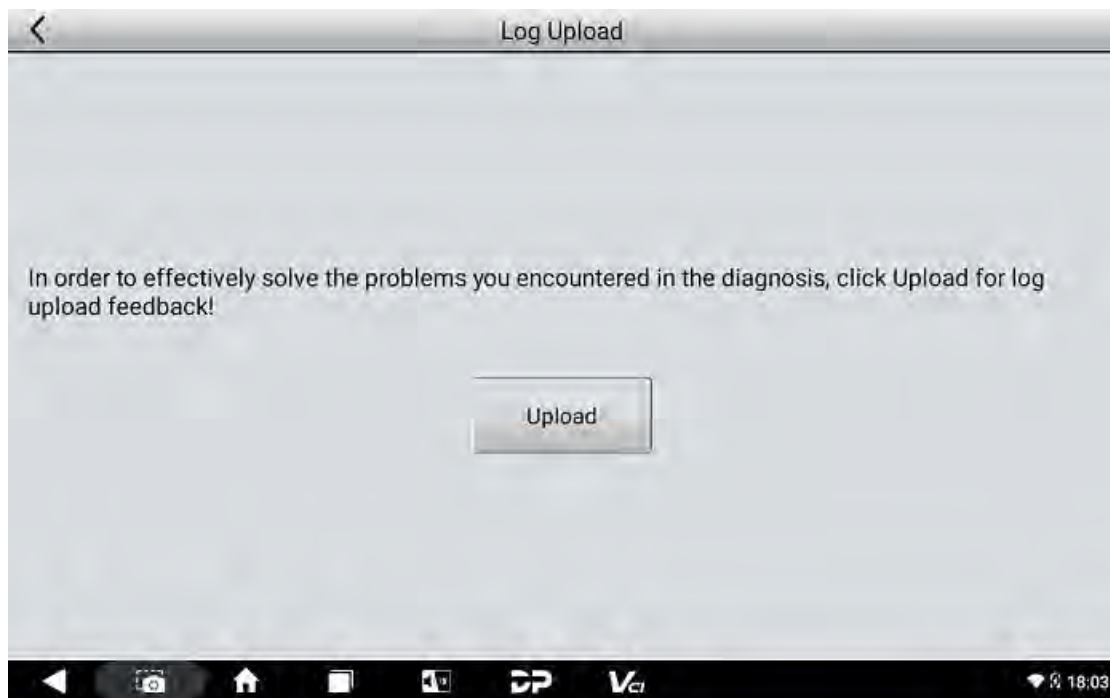

8.5 Team Viewer

For the first time use, the user can see Policy and Agreement page after tapping on **[TeamViewer]** on Support page.

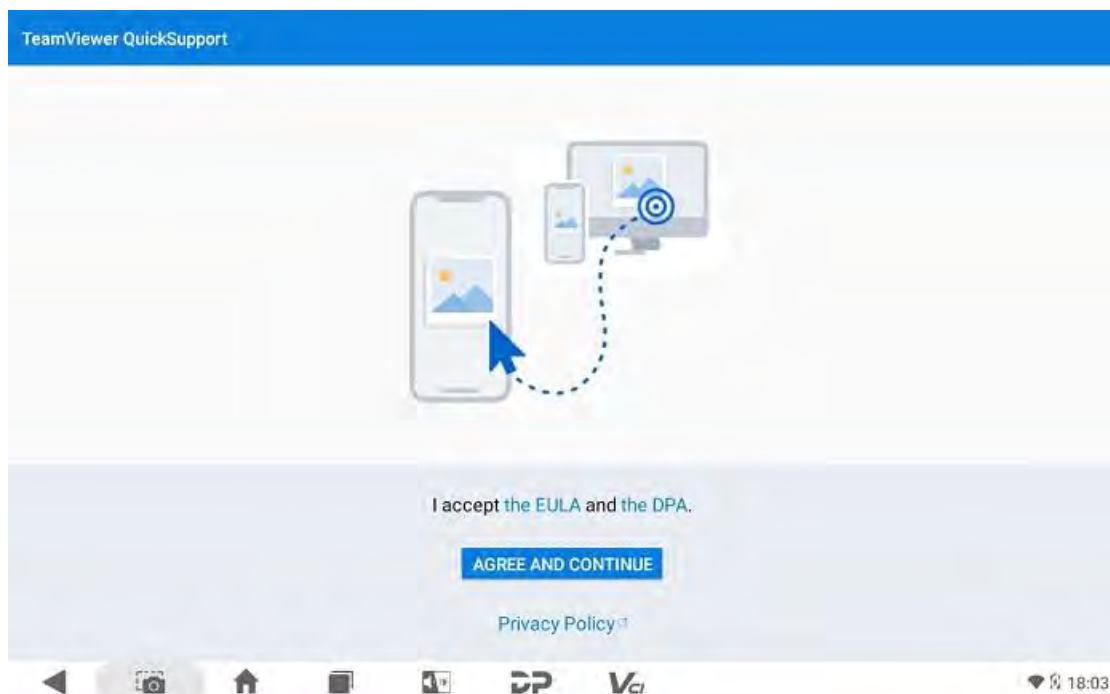

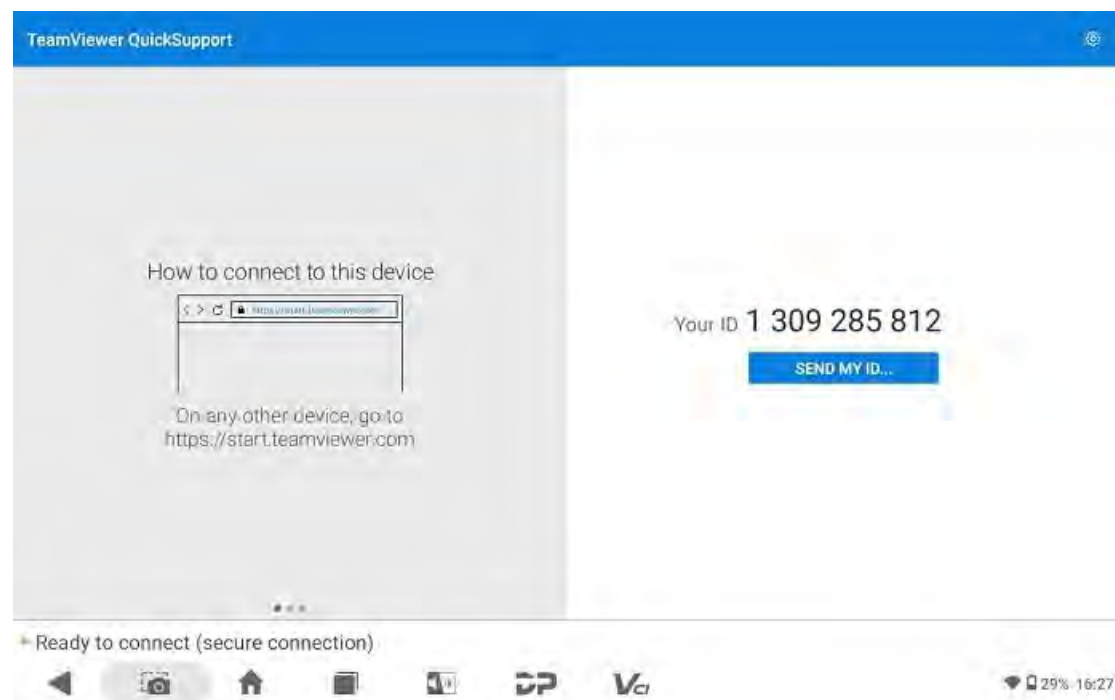

After you fully read the EULA, the DPA and the Privacy Policy, tap the **[Agree and Continue]** button, then follow the instructions to eventually reach the screen showing your ID. Inform the other party of "Your ID", then the other party can apply to connect to this tablet, and the

remote assistance can get started after you agree.



8.6 Feeding Exceptions Back

Select **[Abnormal Feedback]** on the Support main page.

- 1) This feedback record is divided into two categories, "Feedback" and "Pending". "Feedback" is the record that the user has uploaded to the server by tapping **[OK]** after completing the data editing, while "Pending" is the record that the user have tapped the **[Save]** button to save locally but has not uploaded.
- 2) If there are many records, you can use the search box in the upper right corner to quickly find and locate them by the title (red text) or the vehicle brand (such as OBDII).
- 3) The button  in the upper right corner is used for deleting. Tap this button, select the desired record, and then tap button  to complete the deleting operation.
- 4) In the main page of Abnormal Feedback, tap the back button (the one in the upper left corner or the one in the lower left) to return to the previous menu.

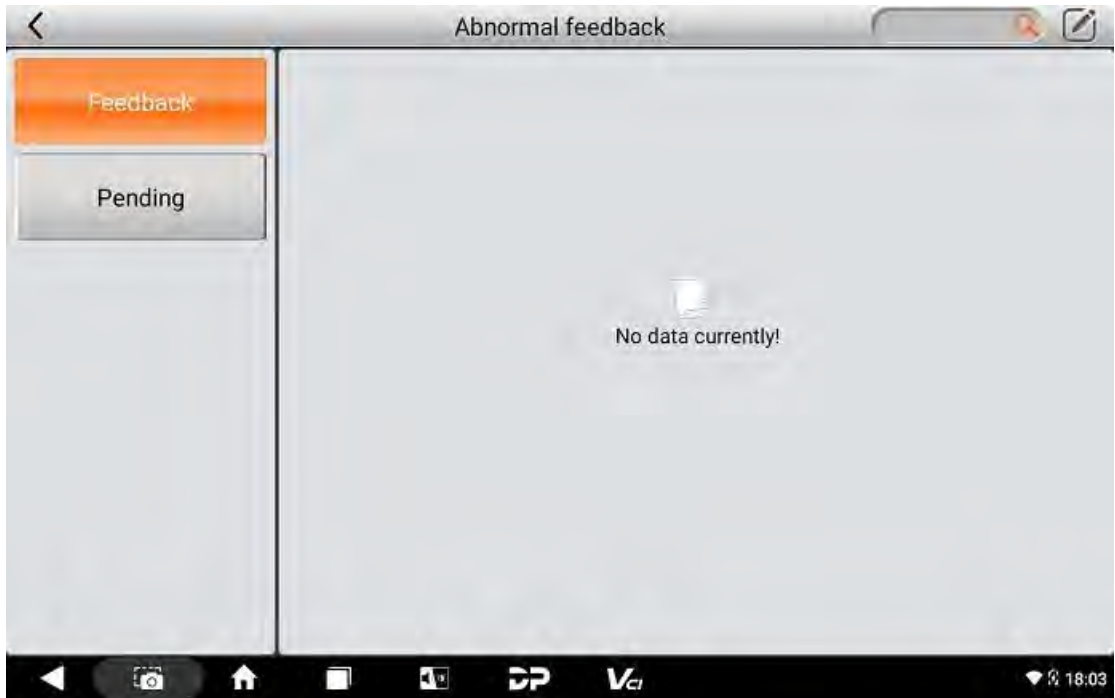

8.7 APP Download

After you select **[APP Download]**, a QR code will pop up. Scan the QR with your cellphone, then you can download OBDSTAR app to enjoy OBDSTAR's service on your mobile.



9 Settings

This function module contains VCI Info, Language, Unit, Workshop, Network Test, Clear cache, System Settings and About.

9.1 VCI Info

The user can see the page as shown in the figure below after tapping on **[Settings]** on the DP page.

- 1) VCI information contains serial number (SN), firmware version, hardware version, software version and device QR code.
- 2) This QR code can be used when binding this device with OBDSTAR APP.

Note: This QR code can only be displayed when the device is powered on and connected to the Internet.



9.2 Language

After tapping on **[Language]** on the Settings page, the user can see all languages supported by the system as shown in the below picture. You can switch system language display via this menu.



9.3 Unit

After tapping on **[Unit]** on the Settings page, the user can see the page as illustrated below. You can select the **[Metric]** or **[English]** unit on this page, and the units displayed in all functions will follow your selection.

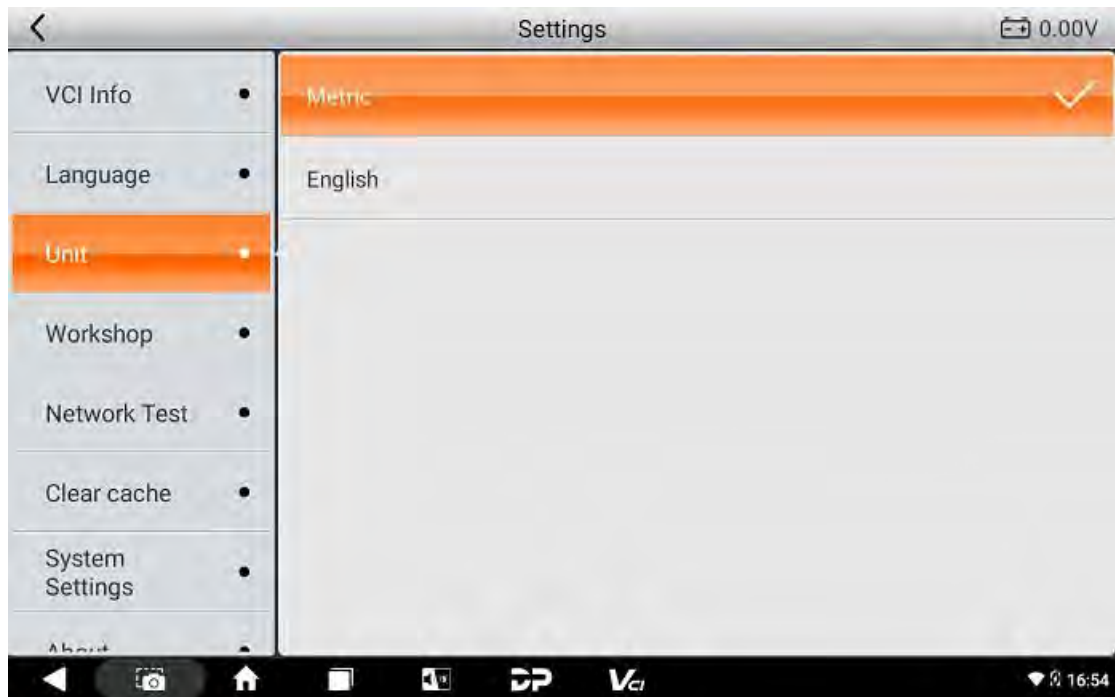

9.4 Workshop

Tapping on **[Workshop]** on the Settings menu, you can set the information of your workshop.

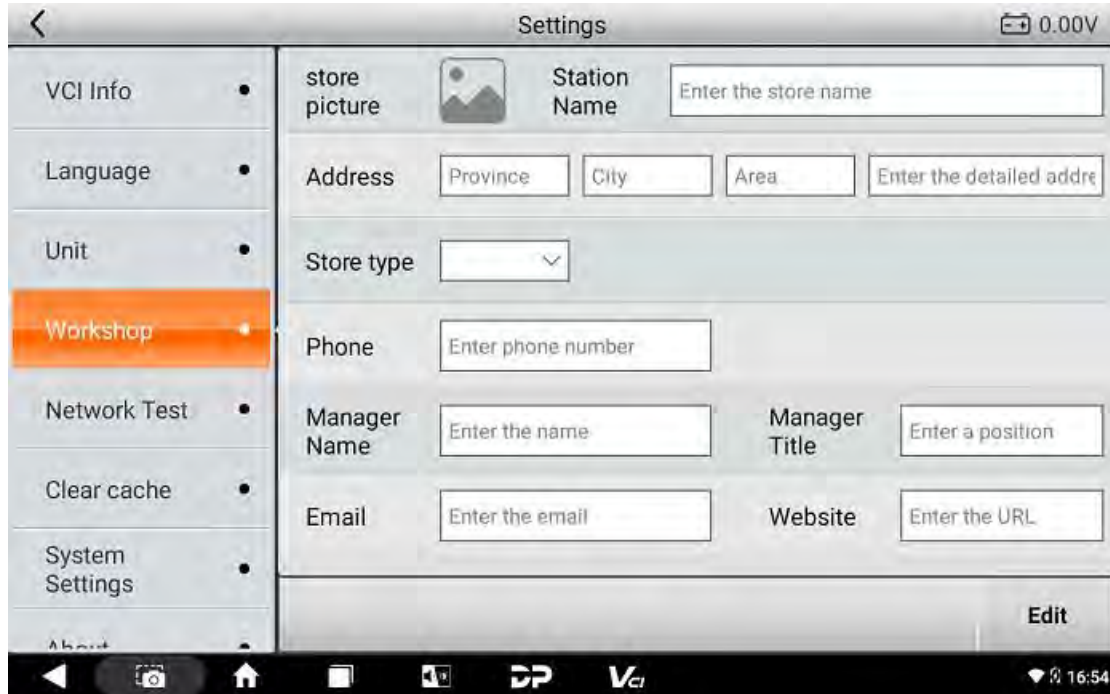

9.5 Network Test

Select **[Network Test]** on the Settings page, and confirm the prompt info to start, then you can see the screen as shown here.



The content to be detected includes network connection status, DNS resolution status, server 1 status, and server 2 status. If the tested item is normal, it will show green button with check mark; if the tested item is abnormal, it will show orange button with exclamation mark.

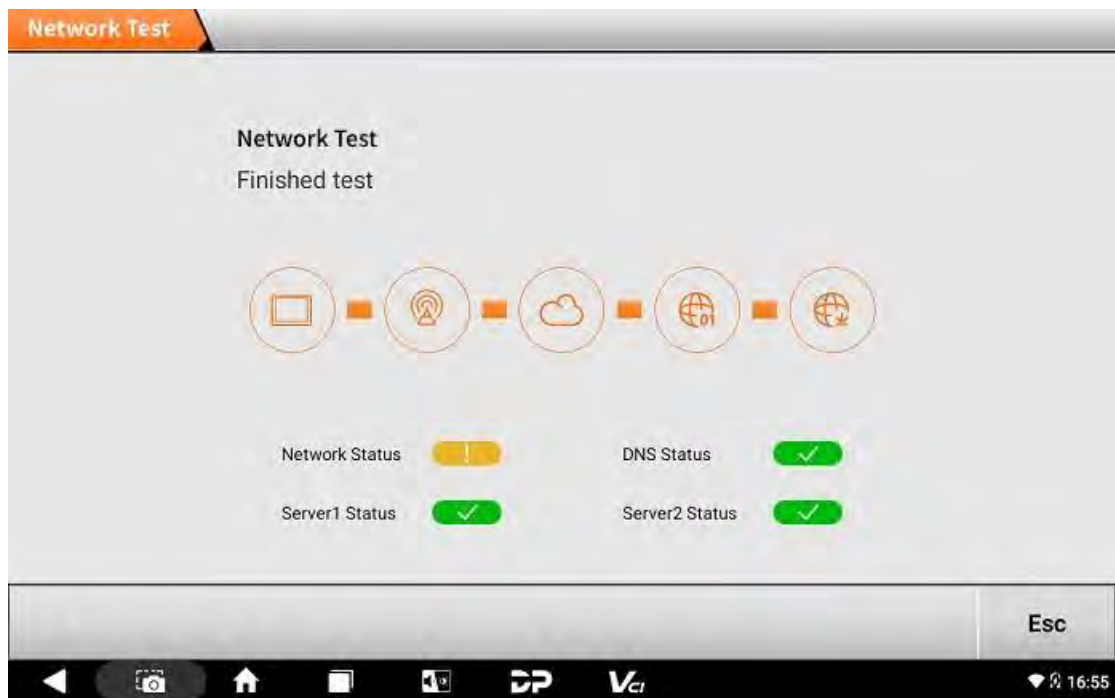

9.6 Clear Cache

Tapping on **[Clear Cache]** on the Settings main menu, the user can see the screen as shown in the following picture. If the device is frozen due to insufficient space, you can try tapping **[Clear Cache]** to solve the problem.

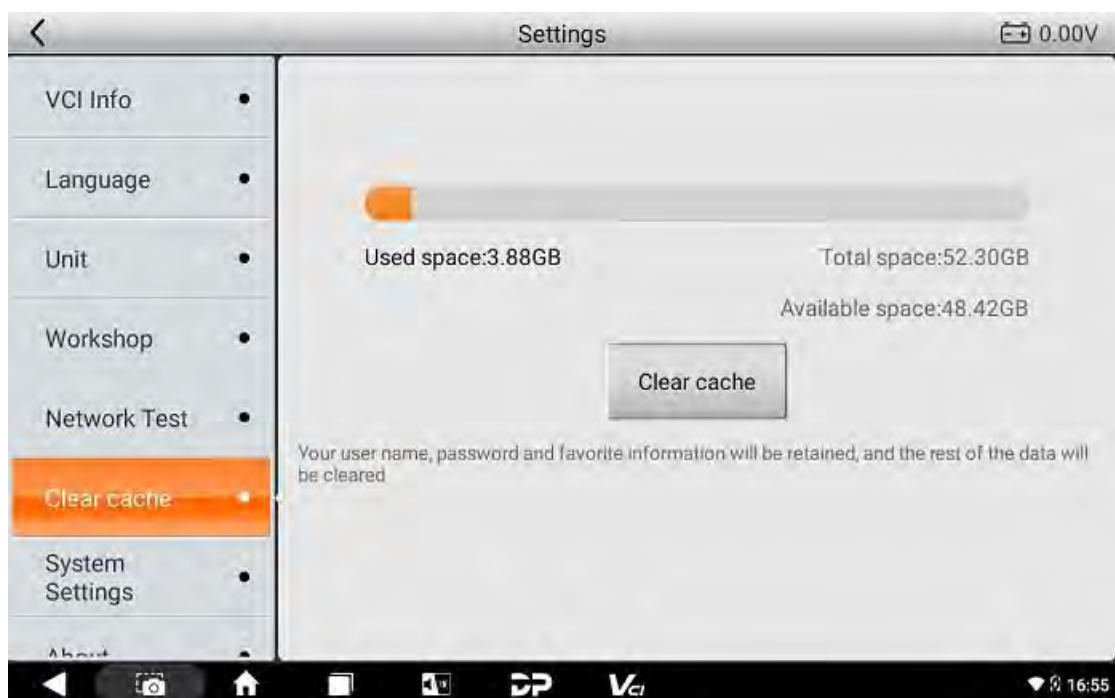

9.7 System Settings

After tapping [System Settings] on Settings main page, you can set system.

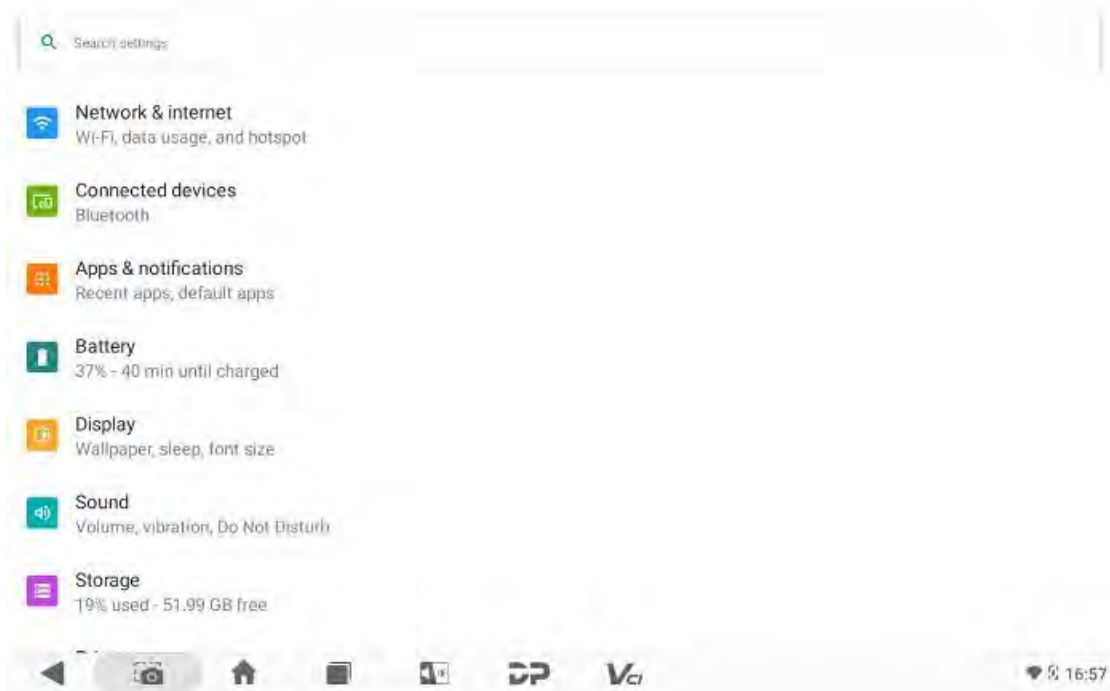

9.8 About

After tapping [About] on the Settings main page, you can see the ECU information and Disclaimer.

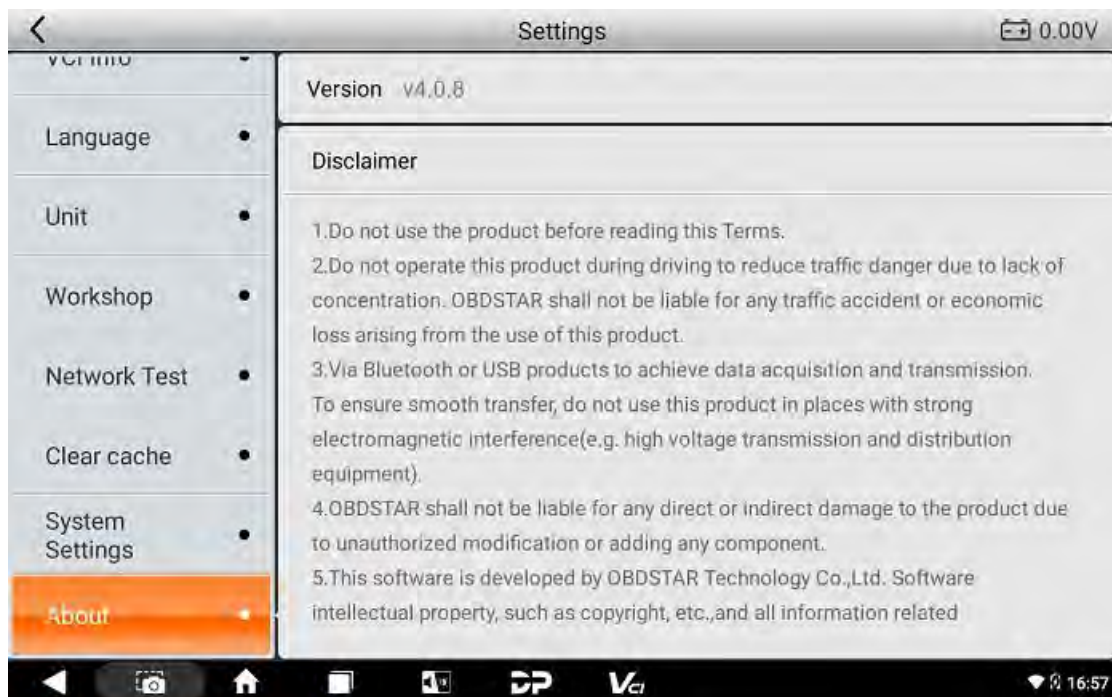



10 Other Apps

10.1 Wi-Fi

You can connect to WLAN (Wireless Local Area Network) to surf the Internet and download software.

10.1.1 Setting Wi-Fi

- On desktop, select **[Settings] > [Network & Internet] > [Wi-Fi]**.
- Tap the bar switch icon behind the Wi-Fi. When it is green , it means Wi-Fi connection is switched on, grey  means it is switched off.

10.1.2 Connecting to WLAN

After switching on your Wi-Fi connection, the product will automatically detect available networks if you are within WLAN coverage. Select the one you need and enter the password to access the Internet.

10.2 Browser

10.2.1 Opening the Browser

Select the browser icon on the desk. This product is configured with Microsoft Edge. If you are using the application for the first time, before visiting the browser homepage, you need to choose whether to log in and whether to set a default homepage.

10.2.2 Browsing Webpages

- On the browser's homepage, you can enter the website you would like to visit in the address field in the upper part of the screen. 

Tip: Tap the star button  behind the address bar to bookmark the website you are currently viewing. You can quickly find the site in your Favorites later.

- After opening a page, slide your finger in all directions to view the page content.

10.2.3 Zooming In/Out Pages

You can zoom in and out of the page in the following ways:

- Tap the screen twice quickly to zoom in on the page and twice again to zoom out.
- Concentrate two fingers on the area you want to adjust, then spread your fingers apart to zoom in or pinch them together to zoom out.

10.2.4 Creating New Pages

On the browser's page, tap the plus icon  in the upper right corner to create a new tab.



10.2.5 Customizing Browser Settings

On the browser's page, tap the  icon in the upper right corner. In the drop-down box, you can check your favorites, history, downloads and so on. And by the Settings, you can manage your account information or change general browser settings.

10.3 Calculator

You can use the calculator to perform basic algorithms for addition, subtraction, multiplication, and division, as well as functional algorithms such as sin, cos, tan, ln, and log.

10.4 Camera

1) Opening the Camera: In any interface, tap the button  to open the shooting interface. Alternatively, slide your finger up on the desktop to expand the hidden menu, then select the camera icon .











2) Mode Selection: In the shooting interface, swipe from the left edge to the right to unfold the photo and recording selection menu , and you can switch between photo and video modes as desired.

Photo Mode: Focus on the image you want to take in the viewfinder and tap the  icon on the right to take a picture.

Video Mode: Tap the icons on the right side:  is for recording,  is for stop.

- 3) Settings: Tap the icon  in the upper right corner of the screen, and the drop-down box allows you to set the flash , grid , and photo timer (3 or 10 seconds) .
- 4) Viewing the Captured Photos/Videos: After shooting, the photos/videos are automatically saved. Swipe your finger to the left to view them. Tap the back button to return to the previous page.
 - When viewing photos, you can perform actions such as deleting, sharing, editing, and viewing details.
 - When viewing a video, you can delete or share the video. When playing a video, drag the progress bar to the right or to the left to fast forward or rewind, tap  to pause, or tap  to start/continue.
- 5) Exiting the Camera: Locate the back button at the bottom of the screen on the far left and tap it twice to exit the camera.

10.5 Gallery

The Gallery application automatically searches for photos and videos stored on the SD card and categorizes them in the corresponding data folder.





Tap the gallery icon on the desktop, select an album, and then tap the screen again to go full screen. Swipe right to see the previous photo and left to see the next.

10.6 Clock

Expand the hidden menu at the bottom of the desktop, tap the clock icon. Its function contains: alarm, clock, timer, stop watch, screen saver and settings.



10.6.1 Alarm

- 1) Select ALARM in the main menu of the Clock.
- 2) Select  to add an alarm.

- 3) Set the alarm time in the popup window.  is for “hh:ss” mode, and  is for dial mode. Then, tap **[OK]** to save the set time.
- 4) In the relevant time column, check Repeat and select a day. All is selected by default. Days to repeat the alarm will be circled in white, whereas the days without the alarm will appear with the original blue background. In addition, you can set a ringtone and label for the alarm in question, or just delete the set alarm. Tap  to hide details and save your alarm. The bar button after each alarm time indicates the status of the alarm, with red for active and white for inactive.
- 5) Tap the arrow button after the time to be deleted to expand the hidden information, then tap  to delete.



Tip: After deleting a set time, you can undo the deletion by selecting the Undo option on the right in the pop-up menu.

10.6.2 Timer

- 1) Select  TIMER in the main menu of the Clock.
- 2) Use the numeric keypad on the right to input the time (e.g., enter 123 for a timer of 1 minute and 23 seconds) .
- 3) Tap  to start the countdown, or tap  to pause.
- 4) What's more, you can select **[ADD TIMER]** to add a new one, or select **[RESET]** or **[DELETE]** according to your needs.

Tip: An alarm will go off when the time is up.

10.6.3 Stopwatch

- 1) Select  STOPWATCH in the main menu of the Clock.
- 2) Tap  to start the count, or tap  to pause.
- 3) Tap the **[LAP]** button, the stopwatch will display a second-round second counting on the right (with the first round record beneath it) while the left side keep on counting from the moment the start button is tapped. And the same with a second tap on the LAP button.
- 4) Tap **[Reset]** to reset the stopwatch.

10.6.4 Custom Settings

- 1) Tap  in the main menu of the Clock, then select **[Settings]** in the dropdown box.
- 2) Clock Settings: Allows you to set a digital/analog style for time, to display time with seconds, to use home clock, to use home time zone, and to change date & time.
- 3) Alarm Settings: Allows you to set how long the alarms will go off, to set snooze length, to set volume and so on.
- 4) Timer Settings: Allows you to set timer sound and to gradually increase volume.

10.7 ES File Explorer

With this application, you can manage the on-device files and send files to a computer via a U drive.

10.7.1 How to Transfer Files Using USB Flash Drive

- 1) Insert the USB flash drive into the USB port of the scanner.
- 2) Expand the hidden menu at the bottom of the desktop, and select **[ES File Explorer]** to open it. In the left side menu, select **[Local] > [Home]**. The block under the Internal Storage block is for the USB storage. See below:



- 3) Open **[Internal Storage]**, select any folder (or open the folder to select files) and hold. A blank circle will appear under each file, and function buttons such as copy, cut, delete, and rename will appear on the bottom right. Select the folder (or file) you would like to transfer, the circle under the selected folder will be marked with a tick and turn green,

then tap **[Copy]**.

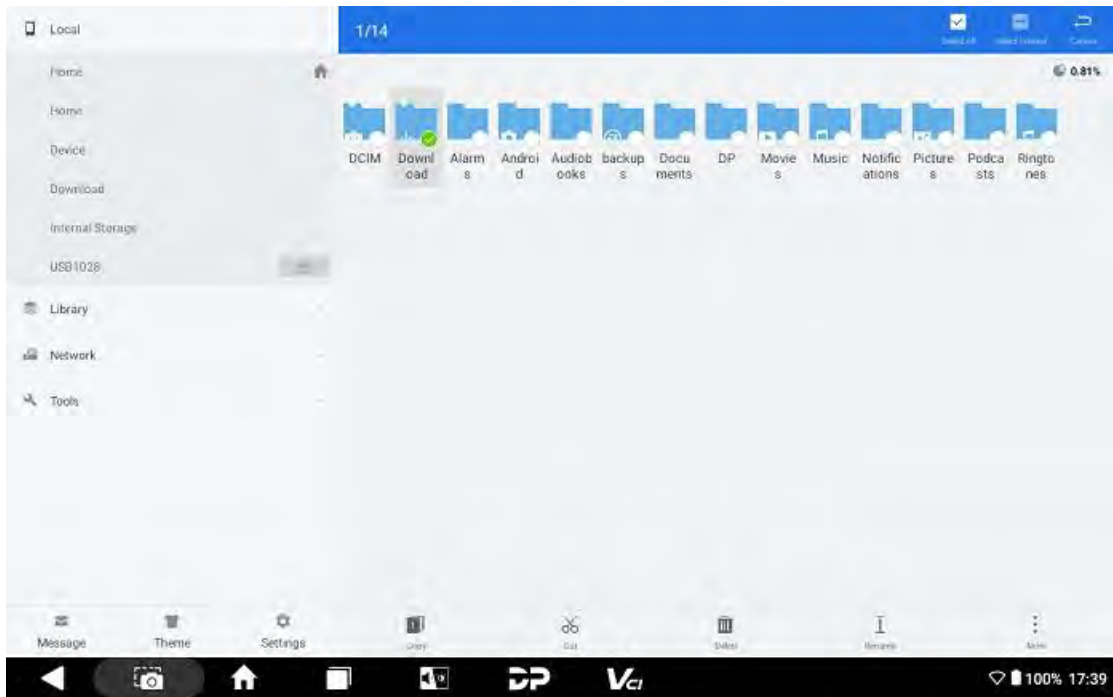

4) Return the Home tab, then select the storage for the USB you've inserted. Check below



5) Open the **[UsbStorage]** folder and all folders in your USB drive will be displayed. (See example below). Paste the copied folder (or file) to the desired location.

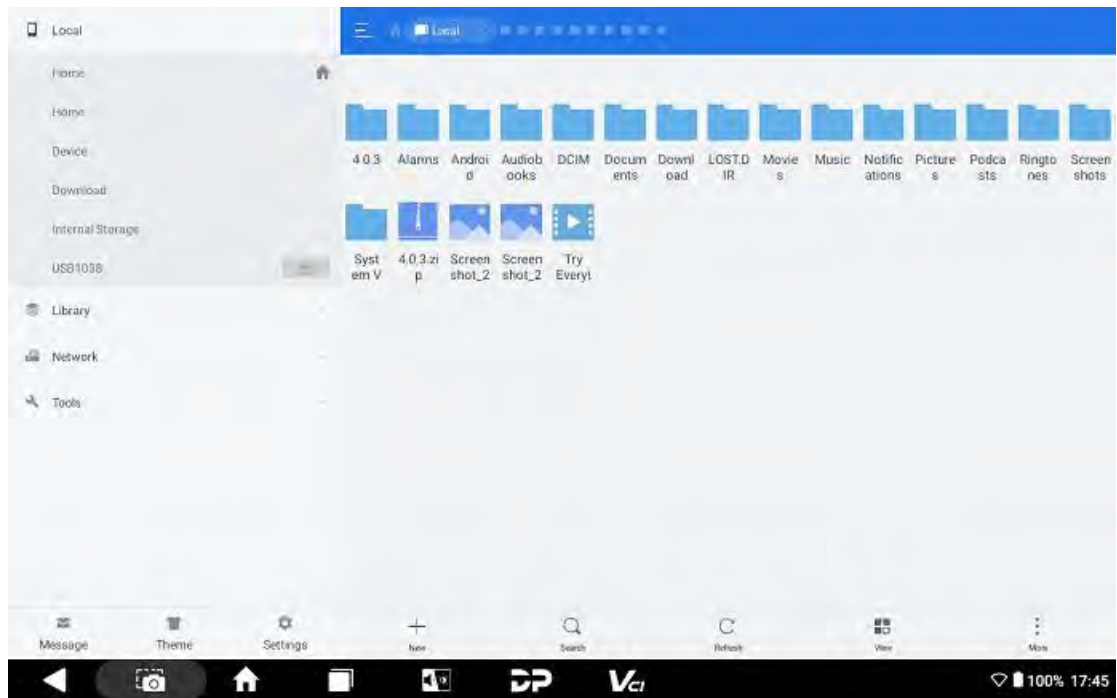

6) After everything is done, just pull out the USB flash drive.

10.8 OTA (Over-the-Air Technology)

If a new system version is available, your Android system can be updated via the Internet.

Procedure:

- 1) Select the Settings icon on the desktop. Alternatively, slide your finger down to expand the notification shade, then tap the settings icon in the lower right corner to open system settings.
- 2) Scroll the settings menu to the bottom, tap **[System updates]**, and the system will automatically check for version updates.



10.9 Screen Recording

- 1) Unfold the hidden menu at the bottom of the desktop and select **[Screen Record]**. Or, you can slide your finger down from the top of any interface to expand the drop-down box, then slide down again to expand the first column and select **[Screen Record]**.

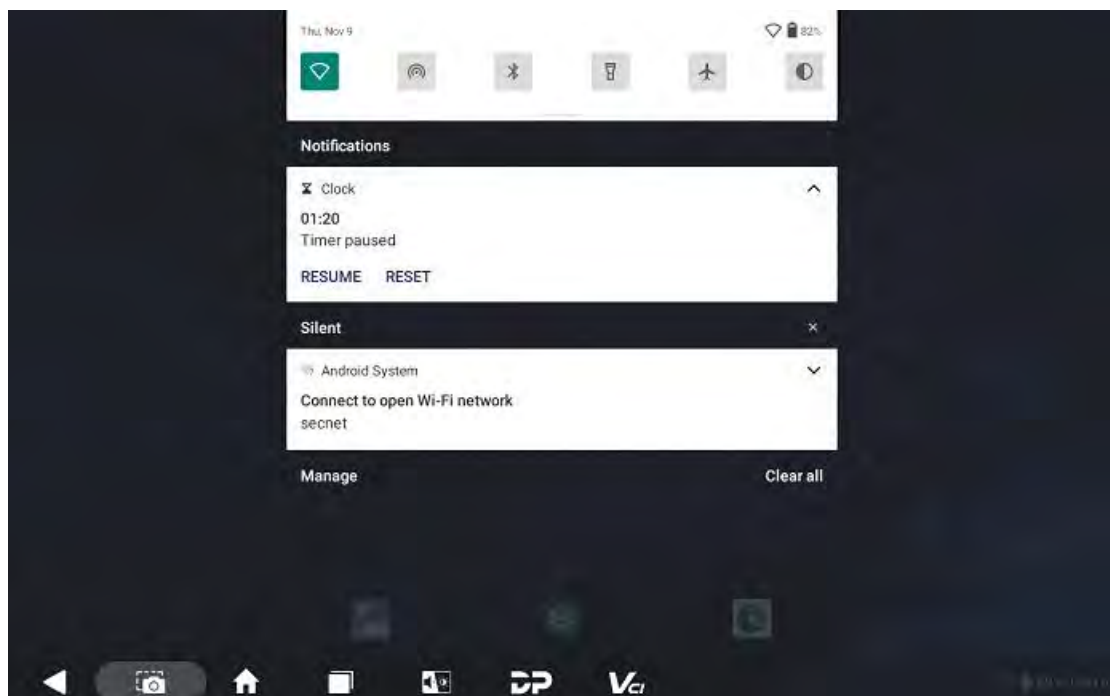

- 2) After tapping **[START]** in the pop-up box, a countdown will appear in the lower right corner, and a tone will sound after three seconds, indicating that recording has started.

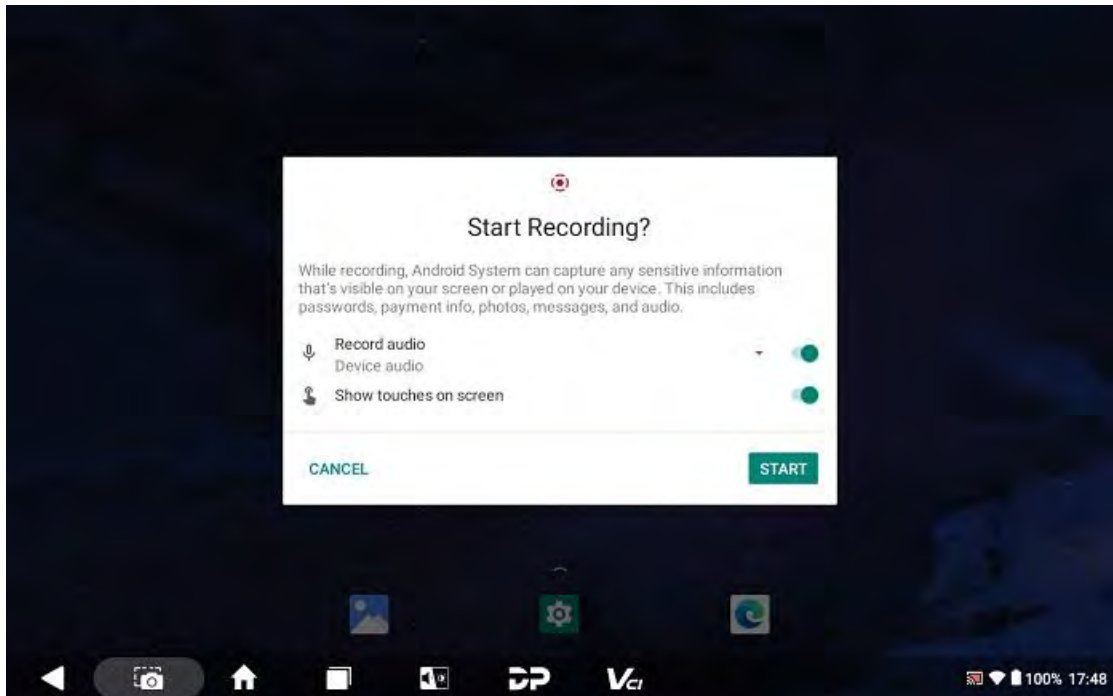

- 3) When you want to end the recording, tap the red icon at the bottom right corner, and the hidden menu at the top of the screen will automatically open, tap **[Screen Record STOP]** to end the recording.

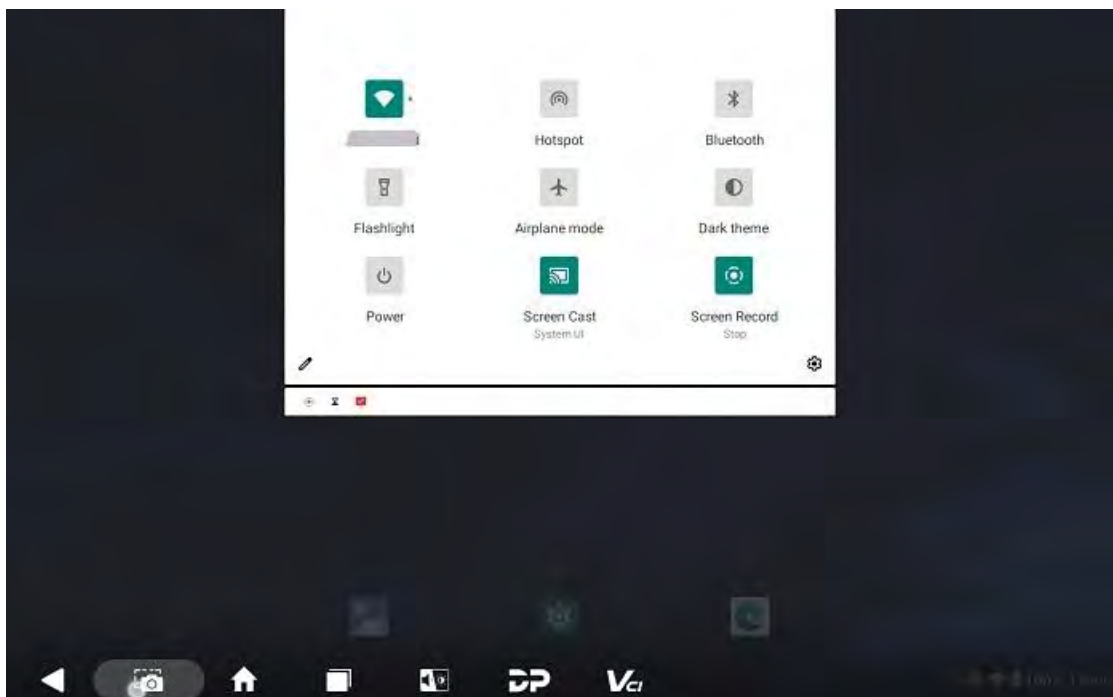

10.10 Screen Projection

Before starting, please make sure that the tablet and the device to be cast are connected to the same network. Slide your finger down from the top of any interface to expand the drop-down box, then slide down again to expand the first column and select **[Screen Cast]**

to turn it on (its icon turns green).

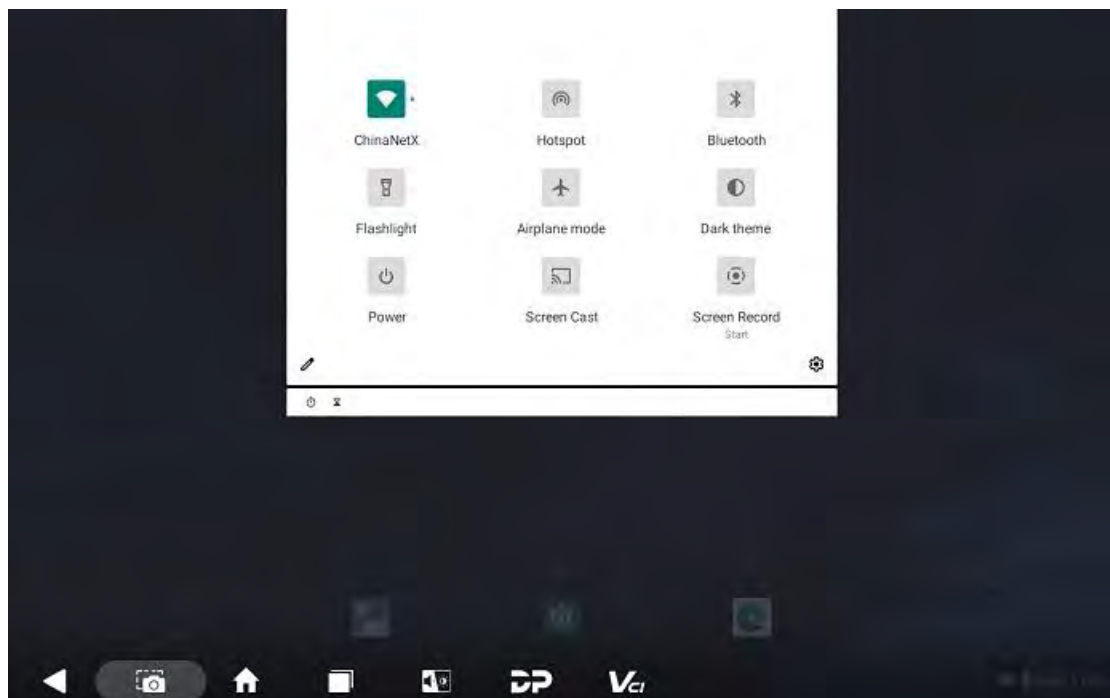

Then, the product will automatically search for available devices, select on the target device to start casting.

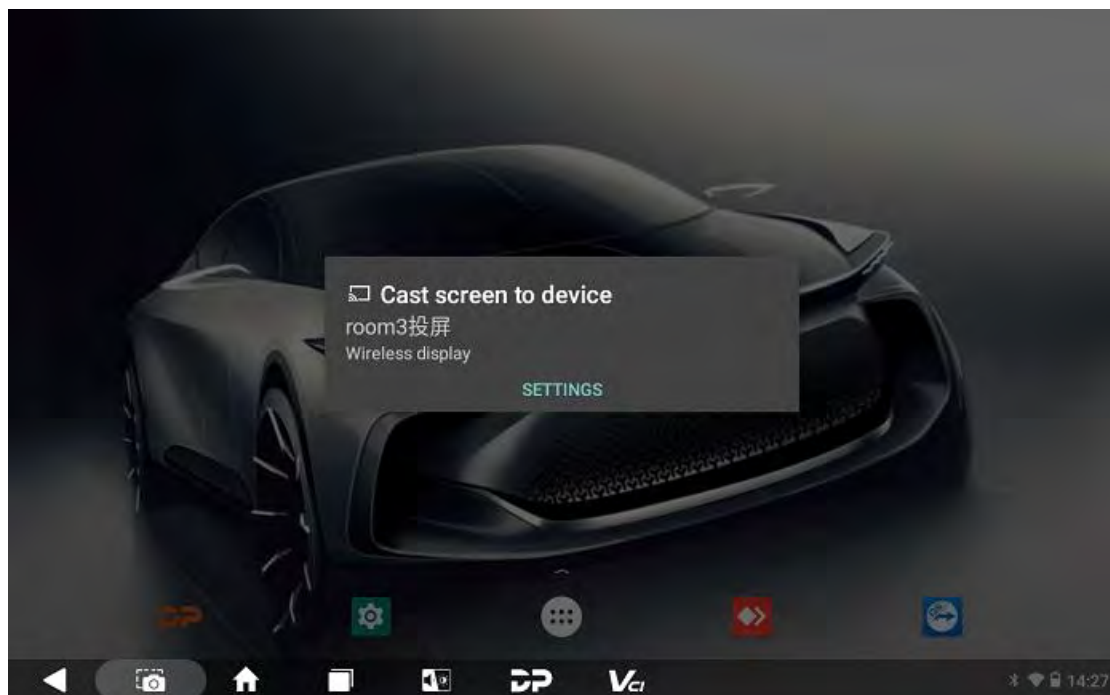

If you want to end the casting, use the back button in the bottom left; or, expand the drop-down box and tap **[Screen Cast]** to turn it off (its icon turns grey).

10.11 Display

10.11.1 Brightness

- 1) Starting from the desktop, select the **[Settings]** icon > **[Display]**.
- 2) Tap **[brightness level]**.
- 3) Drag the slider on the brightness bar to the left to decrease the screen brightness, or to the right to increase it. (Alternatively, you can adjust the brightness in the popup box after selecting the volume/brightness button at the bottom of the screen.)

10.11.2 Auto Orientation

- 1) Starting from the desktop, select the **[Settings]** icon > **[Display]**.
- 2) Scroll down the menu and select **[Screen Orientation]**, and then you can choose Auto, Horizontal screen, Vertical screen, Reverse horizontal screen, or Reverse vertical screen.

10.12 Setting Screen Lock

You can set the screen lock pattern so that when the screen is locked, the screen unlock pattern needs to be drawn correctly before it can be unlocked.

- 1) Starting from the desktop, select the **[Settings]** icon > **[Security]**.
- 2) There are four settings for screen lock: None, Swipe, Pattern, PIN, and Password. If you choose pattern, you have to follow the on-screen instructions step by step to set your screen lock pattern.

10.13 Application Management

- 1) Starting from the desktop, select the **[Settings]** icon > **[Apps & notifications]** > **[SEE ALL 15 APPS]**.
- 2) Select the application you would like to manage. The common operations are OPEN, DISABLE, FORCE STOP, UNINSTALL (not available for some apps), Notifications, Permissions, Mobile data & Wi-Fi, and Storage & cache.

10.14 Languages & Input Methods

10.14.1 Setting Languages

- 1) Starting from the desktop, select the **[Settings]** icon > **[System]** > **[Languages & input]** > **[Languages]**.
- 2) If the language list does not contain the language you need, select **[Add a language]**. After selecting the desired language, the language list will be returned automatically and the language you need will appear in the language list.
- 3) Tap and hold the desired language and drag it to the top; the top language is the language used by the system.

10.14.2 Setting Keyboards

The device provide multiple input methods, and apart from on-screen keyboard, you can connect a physical keyboard to the device.

10.15 Setting Date & Time

This product is preset to use network-provided time.

Note: If the setting is use network-provide time, you will not be able to set date, time and time zone.

- 1) Starting from the desktop, select the **[Settings]** icon > **[System]** > **[Date & time]**.
- 2) Switching off the “Use network-provided time”, then set Date, Time and Time zone respectively. Remember to tap **[OK]** to save your settings.
- 3) You can also set the time display format to use locale default and use 24-hour format. Switching on the Use 24-hour format (blue button) means using a format such as 13:00; switching off the Use 24-hour format (grey button) means using a format like 1:00PM.

10.16 Restoring Factory Settings

Restoring factory settings deletes all data, including downloaded applications, and restores this product to its factory state.

NOTE: Be sure to back up important data on this product before restoring factory settings.

- 1) Starting from the desktop, select the **[Settings]** icon > **[System]** > **[Reset Options]** > **[Erase all data (factory reset)]**.
- 2) Reset this device according to on-screen instructions.

10.17 Storage

Starting from the desktop, select the **[Settings]** icon > **[Storage]** to check the storage status of the device. Content downloaded in the browser will be saved in the local download.

11 Scanner Care

- Keep this device and its accessories dry. Do not use a microwave oven or other external heating equipment to dry it.
- Do not subject the device and its accessories to strong shocks or vibrations, so as not to damage the device and its accessories, or cause the battery to burn and explode.
- Do not expose the device or its accessories to excessively high or low temperatures, otherwise it may result in malfunction, fire or explosion of the device, battery and charger. When the temperature is below 0°C, the battery performance will be limited.
- Do not use potent chemicals, cleaning agents or strong detergent to clean this device or accessories. Before cleaning and maintenance, please turn off the device and disconnect the charger.
- Do not disassemble the device and its accessories, otherwise the device and accessories will not be covered by our warranty.
- If the device hits a hard object or the device is subjected to strong external impact and the screen is partially broken, do not touch or try to remove the broken part, and please stop using it immediately and contact the designated service station in time.

12 Usage of the Battery and the Charger

- When charging is complete, disconnect the device from the power outlet device.
- Do not connect metal conductors to the battery or touch the end of the battery, so as to avoid short circuits and bodily injury such as burns caused by overheating of the battery.
- Do not place the battery or device around heating equipment, such as a microwave oven, oven or radiator.
Batteries may explode when overheated.
- Do not disassemble or modify the battery to prevent the battery from leaking, overheating, igniting or bursting.
- If the battery leaks, do not expose your skin or eyes to the leaked liquid; if the leakage gets on the skin or eyes, rinse immediately with clean water and go to the hospital for medical treatment.
- If the charger's cable is damaged, please stop use it to avoid electric shock or fire.
- Do not throw the battery into the fire, otherwise it will catch fire and explode.

13 Order Notification

Replaceable parts and optional accessories can be ordered directly from the Company's authorized distributors. Please specify the following when ordering:

- Order quantity
- Serial number
- Part name

14 Customer Service Center

If you encounter any problem during the operation, please call our service hotline: +86-755-86707161.

When the device needs repair, please send it, together with the purchase invoice and problem descriptions, to OBDSTAR Technology Co., Ltd.. If the device is covered under the warranty, the Company will provide free maintenance; if the device is out of the scope of warranty, the Company will charge for repairs and return shipping.

OBDSTAR Technology Co., Ltd. After-Sales Service Address:

Floor 2, Block B3, Junfeng Industrial Park, Chongqing Road, Peace Community, Fuhai Subdistrict, Bao'an District, Shenzhen, 51800, China

15 Warranty

One-Year Limited Warranty

Shenzhen OBDSTAR Technology Co., Ltd. (hereinafter referred to as "OBDSTAR") promises to the original retail buyer of this product that within one year from the date of delivery, if under normal use, this product or any part thereof proves to be defective in material or workmanship resulting in device failure, with proof of purchase, the Company will repair or replace it (with a new product or modified part) at no charge to you, depending on the circumstances.

OBDSTAR shall not be liable for incidental or consequential damage caused by misuse, improper operation or improper installation of the device. Because some countries or states do not allow limitations on the duration of implied warranties, the above limitations may not apply to you.

The following are not warranted under this limited warranty under any circumstances:

1. Any product damaged due to abnormal use or abnormal circumstances, accidents, improper handling, human negligence, unauthorized alteration, improper use, improper installation or maintenance, or improper storage;
2. Products whose mechanical or electronic serial numbers have been removed, altered or damaged;

3. Damage caused by exposure to high temperatures or extreme environmental conditions;
4. Damage caused by connecting to or using accessories or other products not approved or authorized by the Company;
5. Defects in the appearance of the product, ornaments, or decorative or structural items such as frames and non-operating parts;
6. Products damaged by external causes such as fire, mud, sand, leaking batteries, blown fuses, theft, or misuse of any power source.